

# + ENABLING CONNECTED INTELLIGENCE

LTE/HSPA+/UMTS/CDMA/EDGE/GPRS  
CONEL CELLULAR ROUTERS  
DESIGNED FOR M2M APPLICATIONS



**B+B SMARTWORX**<sup>®</sup>  
+ CONEL CELLULAR ROUTERS

## The most popular applications ...



### Communications and Transport

- Meteorological measurements on roads
- Traffic density monitoring, camera systems
- Road infrastructure monitoring – traffic signs, crossroads, tunnels
- Parking machines, guidance systems, information boards
- Railway cars – trolley lines exchange stations



### Energy and Heat Industries

- Remote control of high-voltage sectional switches
- Measurement and control of devices in transformer stations
- Remote readouts of electric meters, smart metering
- Monitoring of small power plants – water, wind, photovoltaic power plants



### Camera and Security Systems

- Transfer of images and videos from security IP cameras
- Large camera systems monitoring
- Camera motion control
- Security systems connections



### Point of Sale Systems

- Monitoring of vending and dispensing machines
- Parking ticket machines, highway toll machines
- Self-service gas stations
- Information kiosks



### Environmental Measurement

- Transfer of data provided by meteorological stations and sensors
- Air quality measurement and monitoring
- Flood control systems, early warning information systems for municipalities, cities and industrial enterprises
- Monitoring of volcanoes, prediction of earthquakes and other natural disasters
- Gas and radiation detection systems



### Display and Information Systems

- Monitoring of advertisement billboards and movable/mobile commercial panels
- Video commercial system contents update
- Information kiosks
- Information and traffic navigation systems



# Why choose us?

## + Widely-functional

- OS LINUX
- VPN tunnels, Dynamic routing protocols
- Firewall
- System status, system logs, reboot log
- SMS, E-mail
- Serial server/client, TCP/UDP
- MODBUS TCP/RTU gateway
- DNP3 Outstation
- Backup Routes – Automatic wireless backup of wired WAN connection
- Network management SW R-SeeNet
- Additional SW modules and the ability to create your own SW module
- Secure network tool – Smartcluster
- IEC 101/104 gateway

## + Easy to use

- Very simple and intuitive web-based configuration
- Simple DIN rail installation
- Wide range of feeding voltage
- Wide range of running temperature
- Already implemented list of local mobile carrier APN
- Compatible with common network standards
- Backward compatible with previous versions of the equipment

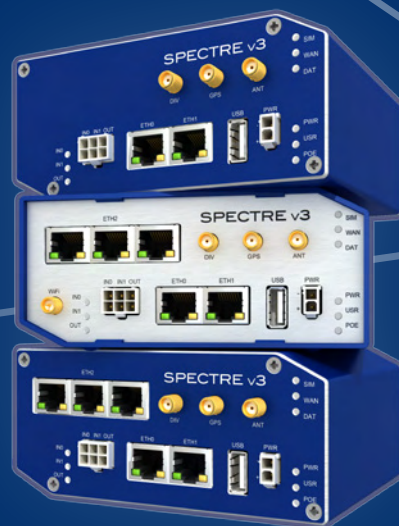

## + All-around support

- Online HelpDesk support
- Online knowledge base
- Application consulting
- Short delivery time and convenient delivery conditions
- International network of local partners
- One CLICK report - current configuration / factory identification /system log / kernel log / reboot log / routing table

## + Reliable

- The electrical components of our routers are rigorously tested for quality all through the entire production process
- Networks with more than 15,000 routers are in action
- Industrial design
- Designed and manufactured in the European Union
- HW and SW watchdog
- ISO 9001
- More than 30 years experience with wireless technologies

## + Modular

- Tempered aluminium or plastic housing
- 2 SIM cards supported
- SD Card holder (v3)
- 2 wireless modules supported
- Ability to create your own SW plugin
- 5 physical interfaces simultaneously
- GPRS/EDGE/UMTS/HSDPA/HSUPA/HSPA/HSPA+/LTE/CDMA
- Optional interfaces: RS232 / RS422 / RS485 / M-BUS / Wireless M-BUS / CNT / ETH / Switch /SD / Wi-Fi / In-Out
- Thousands of possible HW combinations
- Investment protection via HW and SW upgrades

## MODULAR DESIGN – Choose exactly what you need

Basic and full versions are available, with different combinations of optional ports and SIM card holders.

Fixed communication interfaces:

- Ethernet 10/100
- USB Host
- I/O port with 1× input and 1× output

Optional interfaces to optimize according to your application, with the ability to add additional interfaces in the future:

- 1-2× Ethernet 10/100 with available modes:
  - 2-port Ethernet switch
  - 3-port Ethernet switch
  - 2× independent LAN
- Wi-Fi: AP or client mode
- RS232 serial port
- RS485 galvanic separation available
- RS422 galvanic separation available
- MBUS master for up to 30 slave meters
- SD card holder
- Wireless MBUS
- I/O CNT interface including 4× binary inputs (2 inputs may be configured as counter) 2× analogue inputs and 1× binary output

For all routers, you can choose either a metal or plastic casing.

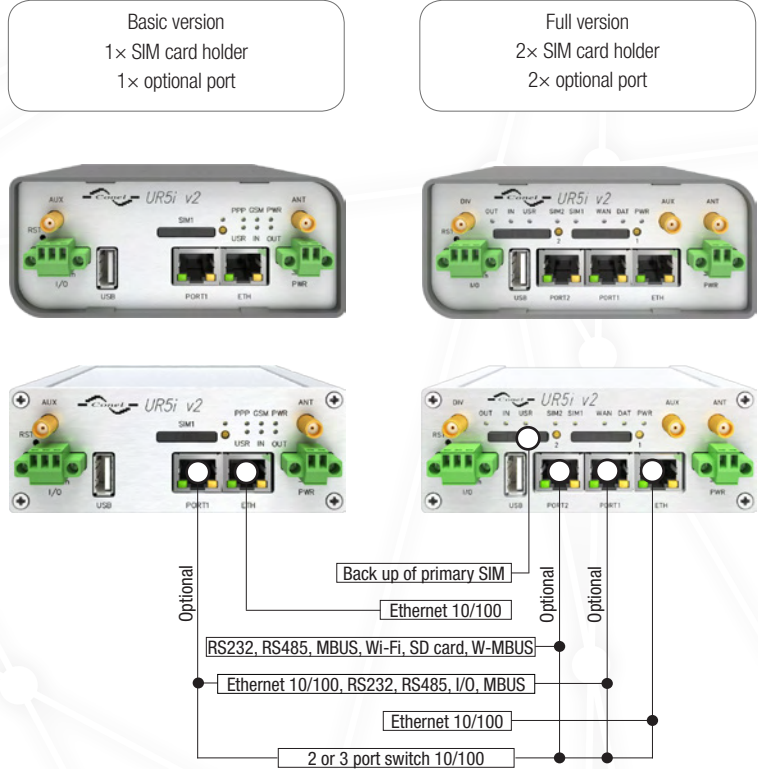

## BALANCED DESIGN - Libratum v2 ... great value, balanced price

All the best from "Modular design" - Balanced routers UR5iv2 Libratum and LR77v2 Libratum HSPA+ and LTE wireless routers featuring high speed data rates (14.4 Mbit/s / 100 Mbit/s).

- 2× Ethernet 10/100 with possible modes:
  - 2-port Ethernet switch
  - 2× independent LAN
- Optional Wi-Fi: AP or client mode
- Dual-SIM fail over
- Antenna Rx Diversity
- Temperature up to +75 °C
- You can choose either a metal or plastic casing

All our routers are compatible with:



LR77v2 Libratum, UR5iv2 Libratum  
 2× SIM card holder  
 2× LAN port, Wi-Fi optional

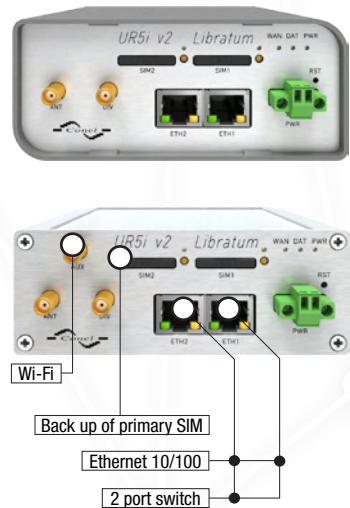

# TWIN MODULE DESIGN - Bivias v2 - For Redundant Reliability

Two independent modules provide automatic failover and reliable connectivity.

- Two independent cellular modules support multiple cellular technologies
- up to 3x Ethernet 10/100 ports with three possible modes: 2-port Ethernet switch, 3-port Ethernet switch, 2x independent LAN
- Wi-Fi: AP or client mode
- GPS available
- optional RS232, RS485, RS422
- optional MBUS master for up to 30 slave meters
- optional Wireless MBUS
- I/O CNT interface included

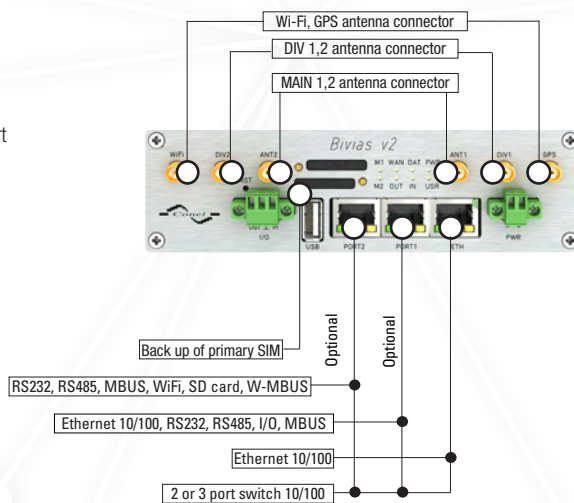

## LTE/HSPA+/UMTS/CDMA/EDGE/GPRS Routers

Choose the right model by data transfer technology:

Conel Router Order Code Generator for v2 line

ROUTER	MOBILE WIRELESS NETWORK TECHNOLOGY	MAX DOWNLOAD	MAX UPLOAD
<b>ER75i v2</b> GPRS/EDGE router	GPRS/EDGE	236,8 Kbit/s	236,8 Kbit/s
<b>UR5i v2</b> UMTS/HSPA+ router	UMTS/HSPA+ & GPRS/EDGE	14,4 Mbit/s	5,76 Mbit/s
<b>UR5i v2 Libratum</b> router	UMTS/HSPA+ & GPRS/EDGE	14,4 Mbit/s	5,76 Mbit/s
<b>LR77 v2 Libratum</b> router	LTE & UMTS/HSPA+ & GPRS/EDGE	100 Mbit/s	50 Mbit/s
<b>LR77 v2</b> LTE router	LTE & UMTS/HSPA+ & GPRS/EDGE	100 Mbit/s	50 Mbit/s
<b>CR10 v2</b> CDMA router	CDMA 2000 1X, EV-DO Rev. A, B, 450 MHz bands	14,7 Mbit/s	5,4 Mbit/s
<b>UCR11 v2</b> UMTS/CDMA router	UMTS/HSPA+ & GPRS/EDGE & CDMA2000 1X, EV-DO Rev A, B, 450 MHz bands	21,1 Mbit/s	5,76 Mbit/s
<b>Bivias v2</b> router	by the modules	by the modules	by the modules
<b>XR5i v2</b> LAN router	ETHERNET 10/100	100 Mbit/s	100 Mbit/s
<b>SPECTRE v3</b> LTE router	LTE & UMTS/HSPA+ & GPRS/EDGE	100 Mbit/s	50 Mbit/s

	ER75i v2	UR5i v2	UR5i v2 Libratum	LR77 v2 Libratum	LR77 v2	CR10 v2	UCR11 v2	Bivias v2	Spectre v3 LTE
<b>Frequency Bands</b>									
GSM 900, 1800 MHz	✓	✓	✓	✓	✓		✓	✓	✓
GSM 850, 1900 MHz	✓	✓	✓	✓	✓		✓	✓	
UMTS (WCDMA/FDD) 900, 2100 MHz		✓	✓	✓	✓		✓	✓	
UMTS (WCDMA/FDD) 850, 1900 MHz		✓	✓	✓	✓		✓	✓	
UMTS (WCDMA/FDD) 900, 1800, 2100 MHz				✓	✓				✓
LTE 800, 900, 1800, 2100, 2600 MHz				✓	✓			✓	✓
CDMA 2000 450 MHz						✓	✓	✓	



## THIRD GENERATION - SPECTRE v3

... more power, more features, more ideas

The **SPECTRE v3** cellular router provides secure Internet connectivity for devices and LANs via the cellular networks. It can be used to provide automatic wireless failover for wired networks, wireless connectivity for devices in remote locations where cable connections are impractical, and wireless connectivity for mobile assets. With upload speeds of up to 50 Mbit/s and download speeds of up to 100 Mbit/s, the **SPECTRE v3** provides ample bandwidth, even for applications that require video.

The Spectre v3 is designed and manufactured for use in tough environmental conditions. Specifications include wide operating temperature ranges from -40 to +75 °C. It accepts input voltage ranges from **10 V DC** to **60 V DC** and is equipped with sleep mode for reducing electrical consumption

The **SPECTRE v3** places intelligence out at the network edge with an extremely powerful Cortex A8 CPU at 1GHz, 256 MB flash memory, 512 MB RAM and 128kB M-RAM, providing full support for LTE (long Term Evolution) speeds and applications. A secure Web interface allows users to configure and manage the **SPECTRE v3** from remote locations. The router can also upgrade its configuration and firmware from the operator's central server, allowing for simultaneous mass reconfiguration of every router on the network. Users may insert Linux scripts and they can create multiple configurations for the same router. Users may switch from one configuration to another at any time

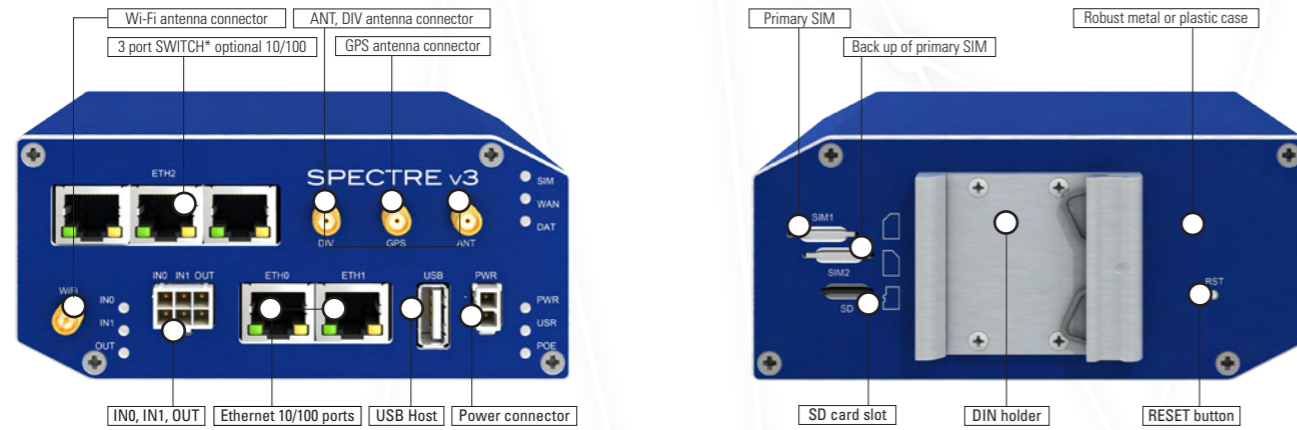

The flexible **SPECTRE v3** can be configured to suit any application. The standard configuration includes 2 Ethernet ports with 2 independent LANs/IP addresses. (The router can be configured with up to 5 total Ethernet ports and 3 independent LANs/IP addresses.) The standard configuration also includes 1 USB host port, 1 microSD card holder, 2 SIM card holders for automatic failover to an alternate service provider, 2 binary inputs(I/O) , 1 binary output (I/O) and onboard GPS. An optional built-in Wi-Fi module is also available, with industrial grade operating temperature ranges from -40 to +75 °C.

The **SPECTRE v3** supports real time data encryption and the creation of VPN tunnels using IPsec, OpenVPN and L2TP. It supports DHCP, NAT, NAT-T, DynDNS, NTP, VRRP, control by SMS, and numerous other functions, as well as additional software like SmartCluster VPN Server and R-SeeNet.

# + SPECTRE v3

Most important characteristics:

- Extremely powerful CPU Cortex A8, 1GHz (2000 DMIPS)
- Memory: 256 MB flash memory, 512 MB RAM, 128kB M-RAM
- 3x independent Ethernet 100 Mbit/s (up to 5 Ethernet ports)
- Optional industrial built-in Wi-Fi module
- MicroSD card holder
- Extended input voltage range from 10 Vdc to 60 Vdc
- Extended operational temperature range from -40°C to +75°C
- Sleep mode for reducing electrical consumption

Conel Router Order Code Generator v3:



Conel Spectre v3 is compatible with:

**R-SEENET**  
**SMARTCLUSTER**



# Overview of routers



	ER75i v2	LR77 v2 Libratum	UR5i v2 Libratum	UR5i v2	LR77 v2	CR10 v2	UCR11 v2	Bivias v2	XR5i v2F	XR5i v2E	SPECTRE v3 LTE	
<b>MOBILE WIRELESS NETWORK TECHNOLOGY</b>												
GPRS	✓	✓	✓	✓	✓	✓	✓	optional			✓	
UMTS/HSPDA		✓	✓	✓	✓	✓	✓	optional			✓	
UMTS/HSPA+			✓	✓	✓	✓	✓	optional			✓	
LTE		✓			✓			optional			✓	
CDMA 2000 1X, EV-DO Rev. A, B						✓	✓	optional				
WAN ETHERNET	optional	optional	optional	optional	optional	optional	optional	optional	✓	✓	optional	
Two VF modules							✓	✓				
<b>COMMUNICATION INTERFACES AND EXPANSIONS</b>												
Ethernet 10/100	✓	2x	2x	✓	✓	✓	✓	✓	✓	2x	2x	
Ethernet 10/100 3-port switch	optional			optional	optional	optional	optional	optional	optional		optional	
Maximum number of ETH ports	3	2	2	3	3	3	3	3	3	2	5	
SD Card Holder	optional			optional	optional	optional	optional	optional	optional		✓	
Wi-Fi (IEEE 802.11 b, g, n)	optional	optional	optional	optional	optional	optional	optional	optional	optional	optional	optional	
USB Host	✓			✓	✓	✓	✓	✓	✓		✓	
RS232/RS422/RS485	optional			optional	optional	optional	optional	optional	optional		✓	
MBUS, Wireless MBUS	optional			optional	optional	optional	optional	optional	optional			
I/O CNT (4x bin. IN, 2x analog IN, 1x output)	optional			optional	optional	optional	optional	optional	optional			
I/O (1xIN/1xOUT)	✓			✓	✓	✓	✓	✓	✓		2xIN / 1xOUT	
GPS Receiver				optional	optional			optional			✓	
<b>CPU, RAM, CONSUPTION, SIM, DESIGN, ENVIRONMENTAL, DIMENSIONS</b>												
CPU Power (DMIPS)	350	350	350	350	350	350	350	350	350	350	2000	
Flash RAM / RAM / M-RAM (MB / MB / kB)	16 / 64 / 128	16 / 64 / 128	16 / 64 / 128	16 / 64 / 128	16 / 64 / 128	16 / 64 / 128	16 / 64 / 128	16 / 64 / 128	16 / 64 / 128	16 / 64 / 128	256 / 512 / 128	
Consumption - Idle / Average / Peak / Sleep Mode	2,3 / 4,5 / 6,5W / -	2,3 / 3,5 / 5,5W / -	2,3 / 3,5 / 5,5W / -	2,3 / 4 / 6W / -	2,3 / 4 / 6W / -	2 / 3,5 / 4W / -	2,6 / 5 / 11W / -	2,6 / 4,6 / 11W / -	2 / 2,5 / 3W / -	2 / 2,5 / 3W / -	2,5 / 4 / 11 W / 10mW	
2xSIM Card	optional	✓	✓	optional	optional	optional	✓	✓			✓	
Antenna Rx Diversity		✓	✓	✓	✓	✓	optional	✓			✓	
Power Supply (V DC)	10 - 30	10 - 30	10 - 30	10 - 30	10 - 30	10 - 30	10 - 30	10 - 30	10 - 30	10 - 30	10 - 60	
Op. Temperature (°C)	-40 to +75	-40 to +75	-40 to +75	-40 to +75	-40 to +75	-30 to +60	-30 to +60	-40 to +75	-40 to +75	-40 to +75	-40 to +75	
Plastic Casing (mm)	51x87x116	51x87x116	51x87x116	51x87x116	51x87x116	51x87x116	51x87x116	51x87x116	51x87x116	51x87x116	55x97x125	
Metal Casing (mm)	42x87x113	42x87x113	42x87x113	42x87x113	42x87x113	42x87x113	42x87x113	42x87x148	42x87x113	42x87x113	55x97x125	
DIN holder TS35/TS32	✓	✓	✓	✓	✓	✓	✓	✓	✓	✓	✓	
<b>FUNCTIONS</b>												
Linux	✓	✓	✓	✓	✓	✓	✓	✓	✓	✓	✓	
IPSec, OpenVPN, PPTP, L2TP, GRE	✓	✓	✓	✓	✓	✓	✓	✓	✓	✓	✓	
Authentication (X.509 certificate, Pre-shared key, PW)	✓	✓	✓	✓	✓	✓	✓	✓	✓	✓	✓	
EasyVPN	optional	optional	optional	optional	optional	optional	optional	optional	optional	optional	optional	
Firewall, NAT/PAT	✓	✓	✓	✓	✓	✓	✓	✓	✓	✓	✓	
DHCP	✓	✓	✓	✓	✓	✓	✓	✓	✓	✓	✓	
HTTP/HTTPS Server, Telnet/SSH, NTP Server, NTP Client	✓	✓	✓	✓	✓	✓	✓	✓	✓	✓	✓	
DynDNS	✓	✓	✓	✓	✓	✓	✓	✓	✓	✓	✓	
FTP Server	✓	✓	✓	✓	✓	✓	✓	✓	✓	✓	✓	
SNMP	✓	✓	✓	✓	✓	✓	✓	✓	✓	✓	✓	
VRRP	✓	✓	✓	✓	✓	✓	✓	✓	✓	✓	✓	
SMTP, E-mail, SMS Functions	✓	✓	✓	✓	✓	✓	✓	✓	✓	✓	✓	
VLAN 802.1Q	✓	✓	✓	✓	✓	✓	✓	✓	✓	✓	✓	
QoS, IGMP, BGP, OSPF, RIP	optional	optional	optional	optional	optional	optional	optional	optional	optional	optional	optional	
PPPoE Bridge	✓	✓	✓	✓	✓	✓	✓	✓	✓	✓	✓	
COM Port TCP/UDP server/client	✓	✓	✓	✓	✓	✓	✓	✓	✓	✓	✓	
MODBUS RTU/TCP Gateway	optional			optional	optional	optional	optional	optional	optional		✓	
4 Configuration Profiles	✓	✓	✓	✓	✓	✓	✓	✓	✓	✓	✓	
Automatic Configuration and FW Update	✓	✓	✓	✓	✓	✓	✓	✓	✓	✓	✓	
<b>ADDITIONAL SOFTWARE SUPPORT</b>												
Support of Software User Modules	✓	✓	✓	✓	✓	✓	✓	✓	✓	✓	✓	
R-SeeNet	✓	✓	✓	✓	✓	✓	✓	✓	✓	✓	✓	
Smart Cluster	✓	✓	✓	✓	✓	✓	✓	✓	✓	✓	✓	



# LTE/HSPA+/UMTS/CDMA/EDGE/GPRS Routers

## ... functions, features, networking, diagnostics ...

### Functions & Software Features

Conel routers enhanced functionality incorporates self-diagnostics and a HW watchdog to ensure secure and consistent operation and ultra-reliable wireless connections.

With dual SIM card holders and automatic failover, these routers provide wireless redundancy for critical applications, along with SMS and email messaging and control capability for remote alerts and resets. They support the most commonly used LAN/WAN network protocols and Conel's custom software allows for easy, flexible and effective networking and management.



### Networking

- DHCP: automatic IP addressing in LAN network
- NAP/PAT: IP address and port translation
- Firewall: filtering of addresses, ports, protocols
- VRRP: virtual backup router function
- DynDNS client: access to the dynamic IP address
- VLAN 802.1Q: virtual LAN
- QoS: quality of service
- PPPoE Bridge: PPP over Ethernet Bridge mode
- Dial-in: communication via CSD
- NTP client, NTP server: time synchronization

### 2x SIM for all FULL version wireless routers

- Back-up by switching between two independent mobile networks
- Switch when data limit is exceeded, when roaming is detected or by any other programmable option

### VPN Tunnelling

- IPSec, OpenVPN, PPTP, L2TP, EasyVPN, GRE
- Authentication by certificates, shared keys, name/password

### Remote Router Supervision & Mass Network Management

- HTTP/HTTPS, Telnet/SSH for local and remote configuration and firmware updates
- Schedule automatic configuration and firmware updates from your FTP/HTTP servers
- Up to 4 independent configuration profiles can be stored and remotely switched using scripts, SMS messages, I/O, etc.
- Additional software for easy networking and monitoring, like SmartCLUSTER and R-SeeNet

### Diagnostics

- Detailed logs of operational information, including signal status and data traffic
- Signal level data, cell identifiers and data traffic are saved in router's memory for up to 2 months
- SNMP: router diagnostics, communication with I/O and MBUS
- LED indication: signal strength, connection status, ports

### SMS & E-mail Info

- Information about status, connection or disconnection and many other parameters
- SMS control: on/off connection, switching SIM, router profile, I/O
- SMS communication: AT commands (RS232 and TCP/IP), I/O or HTTP

### Modular LINUX Software Environment

Open LINUX based system allows use of common LINUX commands, scripts and other features. Conel routers offer an extension of standard firmware with optional software plug-ins. You can create your own plug-in and simply apply it to the router. The router has 128kb non-volatile RAM memory, ready for data collection and processing applications.

### User Modules

- Easy VPN client: secure, encrypted VPN
- Dynamic routing protocols: BGP, OSPF, RIP, IS-IS
- IGMP: multicast protocols
- MODBUS RTU/TCP gateway and mapping: convert data from RTU to TCP/IP format
- Captive Portal
- Need more UM? Please do not hesitate to contact us ...





# SMART DECISIONS BEGIN

## with Intelligent Management Software

### R-SEENET

#### R-SeeNet – Monitoring & Management Software

R-SeeNet is the software system used for monitoring Conel routers. It continuously collects information from individual routers in the network and records the data into a SQL database. Then it creates visual forms and reports for the network administrator.

R-SeeNet consists of two parts:

- R-SeeNet Server**  
 A server application that can be programmed to automatically send SNMP queries (Simple Network Management Protocol) to each router defined in the network. The application retrieves status information from the routers and records it in the SQL database.
- R-SeeNet PHP**  
 A web-based application that accesses to the SQL database and provides the user or network administrator with information about the status of individual routers as well as the status of the entire network.

#### Available Data

Everything you need to know about your network's current status as well as a historical view of the information transferred today, yesterday, this week, this month and last month.

- Signal strength
- Data traffic
- Response time
- Router availability
- Number of PPP connections
- Number of channels connected
- Visual reports, tables and graphs
- Up to 2 months of past data for each router

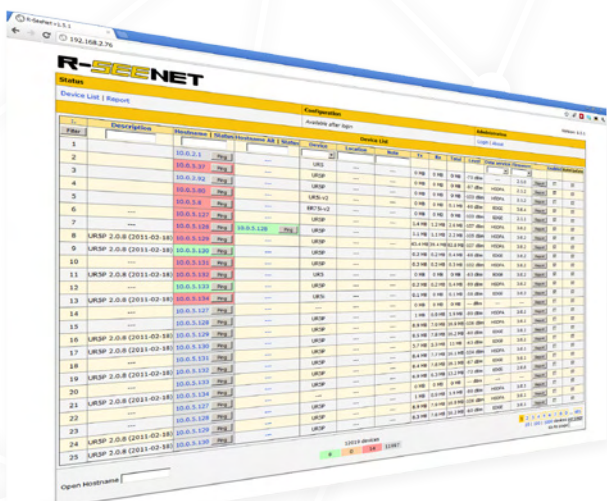

### SMART CLUSTER

#### SmartCLUSTER – Internet VPN Portal

SmartCLUSTER is software designed to create safe communications systems while using a public network - the Internet. SmartCLUSTER is an OpenVPN server that offers three functions for the creation of safe private networks in a public environment.

- As an OpenVPN server it connects clients (Conel routers and end-user computers) via an OpenVPN tunnel. It creates communication links between individual tunnels and thereby enables individual devices to communicate with each other.
- Based on the user-defined network configuration and connection parameters of VPN tunnels, SmartCLUSTER creates a configuration file for Conel routers and also creates secure certificates for both sides of the secured OpenVPN tunnel. This makes it easy for users to add individual Conel routers to a virtual private network, and be confident that the system will be secure against attacks or unauthorized access.
- SmartCluster informs the user about the connection status of individual routers and can be used as an instrument for basic network management.

#### The SmartCLUSTER solution

- SmartCLUSTER makes it easy to connect to devices on local area networks that are behind a router when the router does not have a public IP address.
- SmartCLUSTER solves network security problems and provides secure connections for individual LANs.
- SmartCLUSTER makes it easy to use SIM cards from multiple GSM/UMTS operators.
- SmartCLUSTER also makes it easy to provide inexpensive connectivity for devices that are located in countries with roaming tariffs.

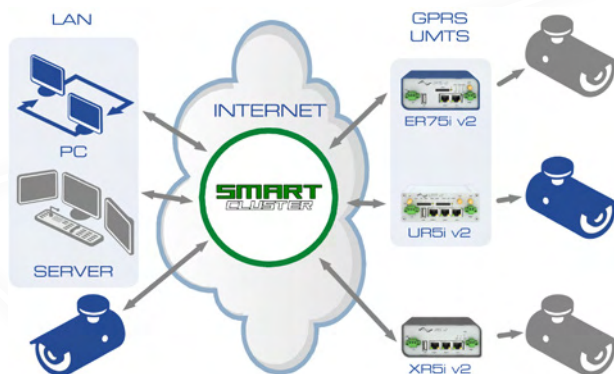



**B+B SMARTWORX®**  
+ CONEL CELLULAR ROUTERS

**World Headquarters**

707 Dayton Road  
PO Box 1040, Ottawa, IL 61350  
USA

Phone: 1-800-346-3119  
Fax: 1-815-433-5109  
Email: [orders@bb-smartworx.com](mailto:orders@bb-smartworx.com)  
Web: [www.bb-smartworx.com](http://www.bb-smartworx.com)

**International Sales**

Westlink Commercial Park  
Oranmore, Co. Galway  
Ireland

Phone: +353 91 792444  
Fax: +353 91 792445  
Email: [eSales@bb-smartworx.com](mailto:eSales@bb-smartworx.com)  
Web: [www.bb-smartworx.com](http://www.bb-smartworx.com)

**Conel s.r.o.**

Sokolská 71  
562 04 Ústí nad Orlicí III.  
Czech Republic

Phone: +420 465 521 020  
Fax: +420 464 647 299  
Email: [conel@bb-smartworx.com](mailto:conel@bb-smartworx.com)  
Web: [www.conel.com](http://www.conel.com)

**Distributor:**

[www.conel.com](http://www.conel.com)

PRO-2015-01-1-EN

**ENABLING CONNECTED INTELLIGENCE**