



HWg-SH4

User guide

Safety information

The device complies with regulations and industrial standards followed in Czech Republic and European Union. The device has been tested and is supplied in working condition. Follow the safety and maintenance conditions in order to keep the device in working condition.

Device housing cannot be opened if the relay contacts are connected to a power network.

Using the device in a manner other than recommended by a manufacturer may cause its protection to fail.

Power supply outlet or a disconnection device has to be freely accessible.

The device must not be used under any of the following conditions:

- The device is noticeably damaged
- The device does not work correctly
- Unsafe parts are moving inside the device
- The device was exposed to moisture or rain
- The device was serviced by unauthorised personnel
- The power adapter or the power supply cable are noticeably damaged

Using the device in a manner other than recommended by a manufacturer may cause its protection to fail. Switches, fuses and means of current protection have to be a part of a construction unit. A manufacturer is not responsible for the device, unless it is used with a supplied or accepted power supply.

Table of contents

Safety information	2
Table of contents	3
HWg-SH4	4
Basic features	5
Connectors	6
First start	7
Web interface	9
Mode selection	10
<i>Offline mode</i>	10
<i>Online mode</i>	10
Usage options	10
<i>Control without door codes (without the keyboard)</i>	10
<i>Control with door codes (with the keyboard)</i>	10
Usage options of HWg-SH4 and subordinated units	11
<i>Adding HWg-SH4x module into HWg-SH4 system</i>	11
Logic architecture of the system	12
Usage examples	13
<i>Use of HWg-SH4 in small applications</i>	13
<i>Use of HWg-SH4 in IT environment</i>	15
Thorough description of the WWW interface	18
<i>General setup</i>	18
<i>E-mail</i>	19
<i>SNMP tab</i>	22
<i>Remote SMS tab</i>	24
<i>DCD server</i>	25
<i>User DB</i>	26
<i>Modules</i>	28
<i>Objects configuration</i>	29
<i>System tab</i>	31
HWg-DCD	32
<i>Basic features</i>	32
<i>Ways of communication between HWg-SH4 and HWg-DCD</i>	32
<i>HWg-DCD interface</i>	34
<i>Typical operations</i>	37
Technical specifications	38
Connecting HWg-SH4 accessories	40
<i>Connecting RFID readers</i>	40
<i>Connection of individual lock types</i>	42
Restoring the default settings	45
Notes	46

Basic features

The HWg-SH4 control unit contains two independent channels (modules) for door control

Each channel contains:

- 3 binary inputs (door contact, exit button, lock contact, etc.)
- 1 output relay switch (max. 50V/1A)

The SH4 unit can connect additional HWg-SH4e and HWg-SH4s units (max.16 units):

- HWg-SH4e units contain two independent channels (modules) for door control
- HWg-SH4s units contain one channel (module) for door control
- HWg-SH4s and HWg-SH4e units can be combined in one system
- Max. number of door channels (modules) controlled by one HWg-SH4 device is 34, including two HWg-SH4 channels

Online / Offline mode

- Offline mode uses only the internal database of RFID tags
- RFID tags database can be managed through a built in web interface in offline mode
- Internal database allows its administrators to manage 2000 user RFID tags

Online mode uses central management server application HWg-DCD

- RFID tags database is stored simultaneously in the central management application and in HWg-SH4 for use in case the connectivity is lost

Supports connecting two independent RFID readers (with or without keypad)

- Support of RFID readers with Wiegand or RS-232 interface
- An option to control LED or buzzers in the reader
- Door to be opened can be selected on the keypad

SNMP for remote supervising in monitoring centers supports sending of SNMP traps in case of any action (door opening, unlocking, card read)

12V power supply input

HWg-SH4 can be installed to 19" racks into its individual 1U holder or to a compound holder, together with other HW group devices

Connectors

LED signalization

- **Power/Status** (green):
 - Light confirms that the device is powered up
 - Flashing indicates firmware uploading or restarting to a factory details
- **INx** (green) – light indicates triggered binary input
- **Outx** (yellow) – light indicates active output relay
- **DCD** (blue) – light indicates connection to a server with HWg-DCD

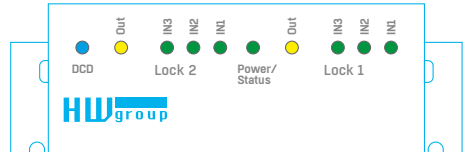

Front panel connectors

- **Power** – power supply connector + terminal block. Input power 9-30V
 WARNING: Input power is directly connected to Power Out!
- **Ethernet** – interface for connecting to a computer network. Follows a 100BASE-T standard (10/100MBit)
- **RFID1, RFID2** – RJ-45 socket for connecting an RFID reader with Wiegand or RS-232 interface
- **Relay** – signalisation relay output - max. 50V/1A. Requires a special firmware version and the functionality depends on this custom FW release. Normally not in use
- **Set** – two control switches:
 - **DIP1** – used for restarting the device to its factory default settings (More in Device reset chapter)
 - **DIP2** – normally not in use

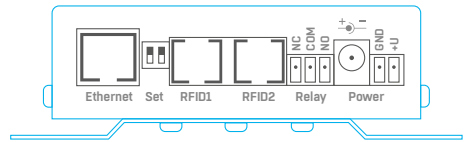

Rear panel connectors

- **Lock1, Lock2** – sockets for connecting door modules. Each module consists of one switch relay (max. 50V/1A) for a lock and three pairs of binary inputs with fixed functions (door contact, exit button, lock contact, etc.)
- **Power Out** – An output for permanent power supply of connected locks. Connected with a Power input.

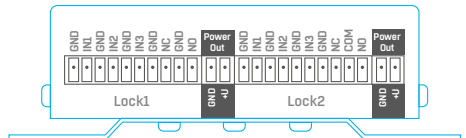

Rj45 standard B colours	Function
white / orange	1 - out 1
orange	2 - out 2
x	3 - Txd
blue	4 - GND
x	5 - in 1
green	6 - DO/Rxd
white / brown	7 - + 12V
brown	8 - D1

RFID connectors RFID1, RFID2 – connections

First start

First steps

1 Connecting the cables

- Note down the MAC address of the device, printed on a sticker on the side of the device
- Check the DIP switches, eventually turn both switches off (**DIP1=Off, DIP2=Off**)
- Connect HWg-SH4 into the Ethernet network (with direct cable to a switches with crossed to PCs) - RJ-45 socket
- Plug the power adapter and connect it to a connector on the device
- Green **POWER** LED will light up
- If the connection to Ethernet network is working, **LINK** LED will light up (orange light on RJ45 connector) and it then flashes during the data transmissions (Activity signalisation)

2 Setting an IP address - HWg-Config

HWg-Config application is located in the main folder on the attached CD (in versions for both Windows and Linux).

This software can be also downloaded from www.HW-group.com Software -> HWg-Config.

- Start **HWg-Config** by clicking on its icon – software will automatically search for connected devices
Automatic search works only in a local network.
- HWg-SH4 can be identified by its MAC address (printed on the side of the device)

UDP Config 4.9.1 for HW group products (www.hw-group.com)

Version: 4.9.1 HW group www.hw-group.com
Config utility for the HW group devices

Your PC network settings
IP address: 192.168.2.11
Netmask: 255.255.252.0
Gateway: 192.168.1.253

Buttons: About... Find Devices

Device list:

MAC	Name	IP	Device type	Port	Parameters
00:0A:59:01:E0:3C		80.250.21.88	IP Watchdog lite	99	TCP setup=Y, DHCP=N
00:0A:59:00:BB:91	kotelna	193.179.198.213	iDo 5.15 Net	0	TCP setup=N, DHCP=Y
00:0A:59:00:B5:7D	Poseidon 3268 online	80.250.21.92	Poseidon model 3268	80	TCP setup=Y, DHCP=N
00:0A:59:00:B2:A0	Rack modrany	193.179.198.212	Poseidon model 3262	80	TCP setup=Y, DHCP=N
00:0A:59:10:20:36	HWg-STE	80.250.21.93	HWg-STE	80	TCP setup=N, DHCP=N
00:0A:59:00:84:A0		192.168.1.63	Unspecified device	23	TCP setup=Y, TEA=N, NVT=Y
00:0A:59:03:10:52	Poseidon 2251 online	80.250.21.89	Poseidon model 2251	80	TCP setup=Y, DHCP=N
00:0A:59:00:88:0D	Damocles MINI online	80.250.21.87	Damocles model MINI	80	TCP setup=Y, DHCP=N
00:0A:59:03:1A:16	Poseidon 4002	192.168.1.77	Poseidon 4002	80	TCP setup=Y, DHCP=N
00:0A:59:03:14:34	Poseidon 1250 online	80.250.21.84	Poseidon model 1250	80	TCP setup=Y
00:0A:59:03:19:CA		192.168.1.96	Poseidon 4001	80	TCP setup=Y, DHCP=Y
00:0A:59:03:19:89		192.168.1.95	Poseidon 4001	80	TCP setup=Y, DHCP=N
00:0A:59:03:19:A0	Poseidon 4001	192.168.1.91	Poseidon 4001	80	TCP setup=Y
00:0A:59:03:19:9A		192.168.1.96	Poseidon 4001	80	TCP setup=Y
00:0A:59:03:14:58	Damocles 2404	80.250.21.86	Damocles model 2404	80	TCP setup=Y, DHCP=N
00:0A:59:03:0E:41	Poseidon 3265	80.250.21.85	Poseidon model 3265	80	TCP setup=Y, DHCP=N
00:0A:59:00:83:95	Poseidon 3262	80.250.21.90	Poseidon model 3262	80	TCP setup=Y, DHCP=N
00:0A:59:01:88:54		172.20.192.110	PortStore4	80	TCP setup=Y, DHCP=N

Ready

Annotation: Double-click for detail (pointing to the Poseidon 4001 row), see page 8 (pointing to the table)

First steps

- Clicking on a MAC address of the device opens a window for setting up its basic network parameters.

Setting network parameters of the device:

- IP address / HTTP port (in default 80)
- Mask of the network
- Gateway IP address for the local network
- Device name (You can choose the name)

Save the settings with **Apply Changes** button

To set the IP address you can also use:

- **UDP Config for Linux**

The 'Details' window shows the following configuration:

Name: Poseidon 4002	IP address: 192.168.1.77	Port: 80
<input type="button" value="Open in WEB Browser"/>		
Mask: 255.255.252.0	MAC: 00:0A:59:03:1A:16	
Gateway: 192.168.1.253	FW version: 2.0.4	
<input type="checkbox"/> Enable IP access filter	Device type: Poseidon 4002 (26)	
IP filter value: 0.0.0.0	DHCP: Supported	
IP filter mask: 0.0.0.0	<input type="checkbox"/> Enable NVT	
Default values		
<input type="button" value="Load defaults"/>		
<input type="checkbox"/> Enable DHCP		
<input checked="" type="checkbox"/> Enable TCP setup <input type="button" value="Open"/>		
<input type="checkbox"/> Enable TEA authorisation		
<input checked="" type="checkbox"/> Check if new IP address is empty		
<input type="button" value="Cancel"/> <input type="button" value="Apply changes"/>		

Ready

Important



In case the device stops working because of a wrong configuration set, the settings can be restored to the factory defaults. More in restoring the *default settings* chapter.

3 WWW interface

WWW interface of the device can be opened by one of the following steps:

- Open the device's IP address in a web browser
- Click the IP address in HWg-Config application

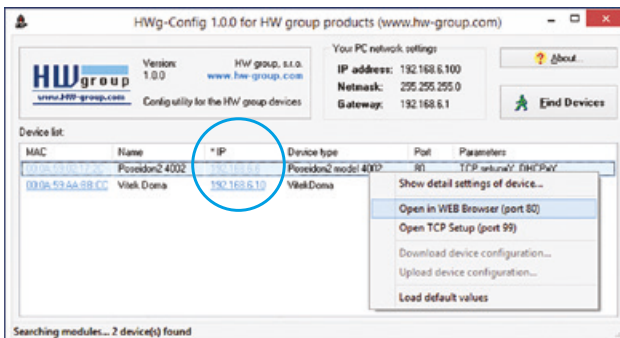

First steps

Web interface

- Home** actual values overview
- General Setup:** IP address, DNS, security options (login/password)
- Email:** settings and email test options
- Time:** time parametrs, NTP server
- Remote SMS:** settings and test SMS options
- DCD Server:** HWg-DCD server connection settings
- User DB:** users and offline mode rights management options
- Modules:** output control options and alarm settings
- SNMP:** SNMP / SNMP traps settings (ports and alarm messages recipients)
- System:** FW upgrade, configuration download options, etc.

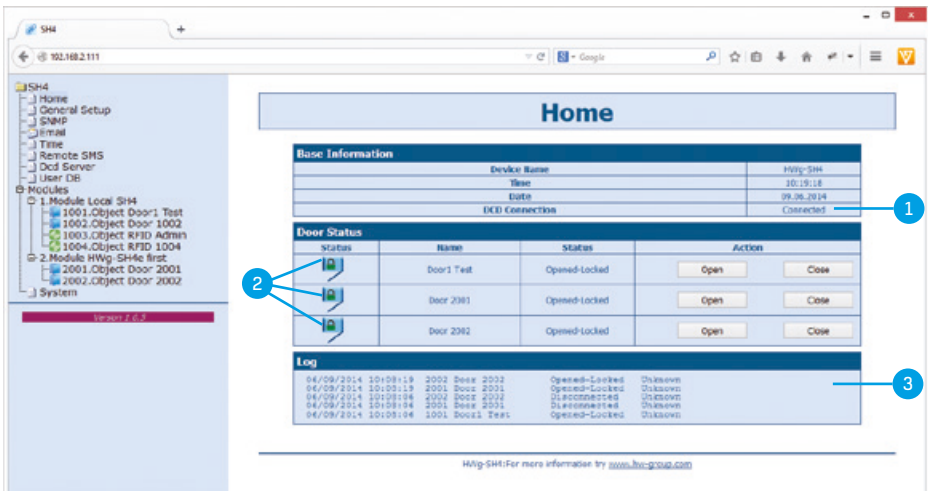

1 HWg-DCD connection status

2 Doors state & manual control options

3 List of the most recent actions including RFID tags.



Door closed and unlocked – can be opened



Door closed and locked



Door opened and unlocked



Door opened and locked – door opened by an authorized user, waiting to be closed



Door disconnected – connection with module lost

Mode selection

For testing of HWg-SH4 in offline mode you can keep the unit in the default settings, only with connected RFID reader.

Offline mode

Offline mode enables users to start using the access system HWg-SH4 immediately. Users can be added, edited or removed manually on the User DB tab. This way of use is preferred to be used only for managing a single HWg-SH4 unit with a small number of users.

Advantage of this mode is that administrators of the system can immediately react and open doors or manage users.

Central user management with more doors and online user database backup are not available in this mode. A manual authorization with a master tag is required for assigning available RFID tags.

Online mode

A mode in which the access system is used together with HWg-DCD for managing users and doors. All users are managed through the HWg-DCD application (can be run on any PC, in case the DCD server is available on the Internet/Ethernet network). The access rights are afterwards copied to HWg-SH4 devices.

Main advantage of this mode is its ability to manage large networks with many users, HWg-SH4 units and subordinated units HWg-SH4e and HWg-SH4s. Online mode also allows administrators to work with unknown tags, that can be loaded into the system and assigned, after the user is authorized.

Online mode requires a central server and the HWg-DCD application. However this server does not have to be constantly online, in case a permanent surveillance is required.

Usage options

Control without door codes (without the keyboard)

One standard RFID reader is connected to HWg-SH4 in basic configuration. After reading a tag with access rights for door opening, the device unlocks the door. One RFID tag can be allowed to open front, back or both doors connected to the unit.

Control with door codes (with the keyboard)

In this mode you need to connect the RFID keypad reader to the HWg-SH4. Each door has its own numeric code which has to be entered and then confirmed by an RFID tag in order to unlock the door. HWg-SH4 then evaluates the code and the tag and opens **each door** associated to this code and **also each door with no code assigned**.

Usage options of HWg-SH4 and its subordinated units

Up to 16 HWg-SH4e and HWg-SH4s units can be connected to HWg-SH4:

- HWg-SH4e units contain two independent channels (modules) for door control
- HWg-SH4s units contain one channel (module) for door control
- HWg-SH4s and HWg-SH4e units can be combined within one system
- max number of door channels (modules) controlled by one HWg-SH4 unit is 34, including two channels on HWg-SH4

Connected modules communicate with HWg-SH4 using a TCP connection.

Subordinated units can be connected to HWg-SH4 on a configuration level. These units are identified as modules of their master HWg-SH4.

Adding HWg-SH4x module into HWg-SH4 system

Units subordinated to HWg-SH4e and HWg-SH4s can be added through the WWW interface of HWg-SH4 on Modules page by *Add Module* link.

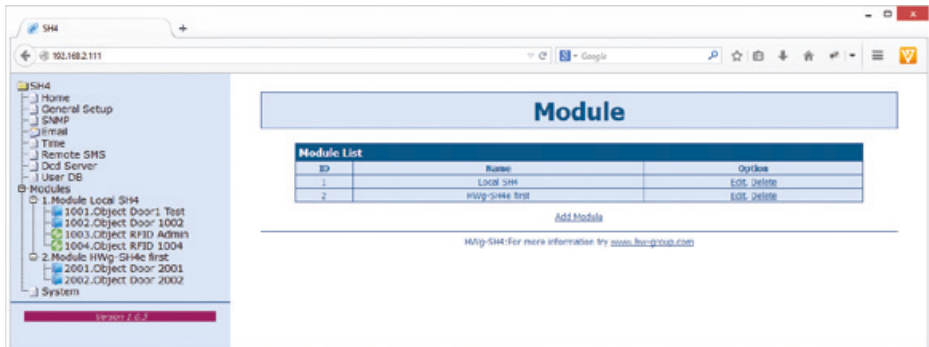

You need to enter the following

Module Name – under this name the module will be identified in the HWg-SH4 system and eventually also in the HWg-DCD application

Type – type of the subordinate module

IP Address – IP address of the connected unit

Username – username for communication security, defaults to „user1“. The subordinated unit has to be reconfigured manually in case any changes are done. More information can be found in the manual for the units

Password – password for communication security, defaults to „pass1“. The subordinated unit has to be reconfigured manually in case any changes are done. More information can be found in the manual for the units

Logic architecture of the system

HWg-SH4 system is built on a hierarchy of **MODULE** => **OBJECT** => **ELEMENT**.

- Modules are physical devices like the HWg-SH4, HWg-SH4e, HWg-SH4s and others. Each module contains one or more objects.
- Object represents door type objects, RFID readers and relay type objects – (Relay type objects chapter). Each object contains one or more elements.
- Element represents the lowest point of hierarchy. Represents output relays, binary inputs, Wiegand interface or RS-232. Elements ARE NOT defined by users!

Module	Number of objects in types		
	Door	RFID	Relay
HWg- SH4	2	2	1
HWg- SH4e	2	0	1
HWg- SH4s	1	0	1

Component	Elements		
	Binary Inputs	Relay Outputs	RS-232/ Wiegand
Door	3	1	0
RFID	0	0	1
Relay	0	1	0

Door type object

Door objects are used to control locks, lock sensors, for door opening detection or for connecting exit buttons. This object consists of four elements – 3 binary inputs + 1 relay output. Elements create a whole unit and CANNOT be managed separately.

Predefined objects:

Door Model	Element		
	IN1	IN2	IN3
Magnetic Lock	Door contact	Not used	Exit Button
Soutchco R4-EM Rotary	Door contact	Switch	Not used
Soutchco H3-EM - Electronic Locking Swinghandle	Door contact	Lock status	Mech status

More object types can be added on request. If you have a request on object types, please contact your distributor.

RFID type object

Used for connecting RFID readers through Wiegand interface or RS-232 into an RJ45 connector.

Predefined objects:

RFID reader	Interface	Keyboard	Frequency	Standard	Audio output	Optical output
HWg-R3	Wiegand	Yes	125kHz	EM4100	Yes	Yes
JA-80H	Wiegand	Yes	125kHz	EM4100	Yes	Yes
RFID reader 232-M1	RS-232	NO	13,56MHz	Mifare	Yes (not defined)	NO (not defined)

Both RFID readers are connected independently and types of the readers can be combined. You can then for example connect an EM4100 together with Mifare reader, which would allow its users to use RFID tags they already have. Or you can use one reader with a keyboard at the entrance to a building and another reader without a keyboard at the exit.

Relay type object

Relay type objects CANNOT be controlled manually in standard version of the product. They can be used to control signalization, to identify selected door in large rack systems or for switching internal lighting in telco rooms, etc. To get more information on possible usage options of the relays, please contact your local distributor with your request.

Usage examples

Using HWg-SH4 in small applications

The small applications can be for example apartment houses, small companies, or systems using existing RFID tags.

Apartment building access system

HWg-SH4 can be used as an access system for apartment houses or offices. A typical application can be using RFID reader for access from the outside of the building, together with an exit button installed on the inner side of the door. To enter the house you can then simply use the RFID tag and to leave the building you can press an exit button. The door can be also opened remotely from individual apartments. The system can also be used to control the gate to a parking lot.

Using HWg-DCD in such cases is optional, as it is not needed for direct administration. However it can notably simplify registering of access tags and deactivation of the lost ones.

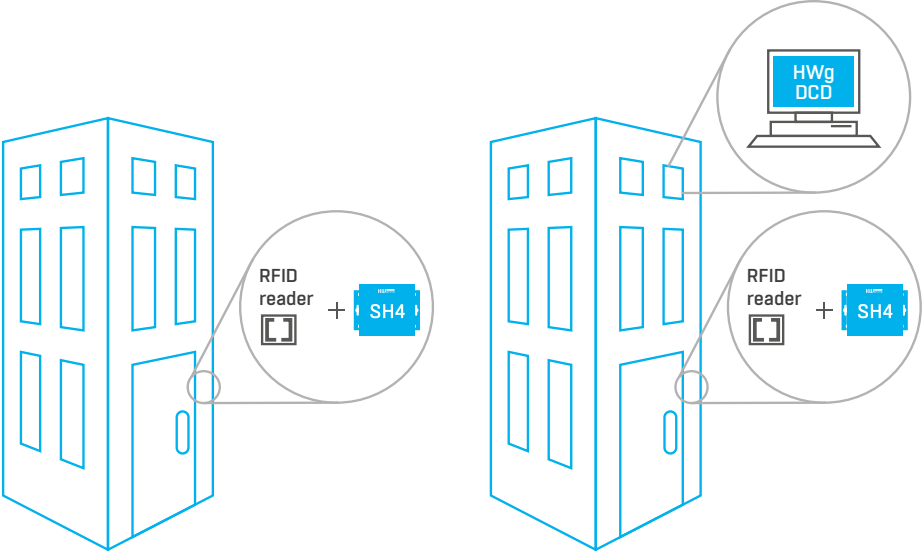

Solution without HWg-DCD

Solution with HWg-DCD

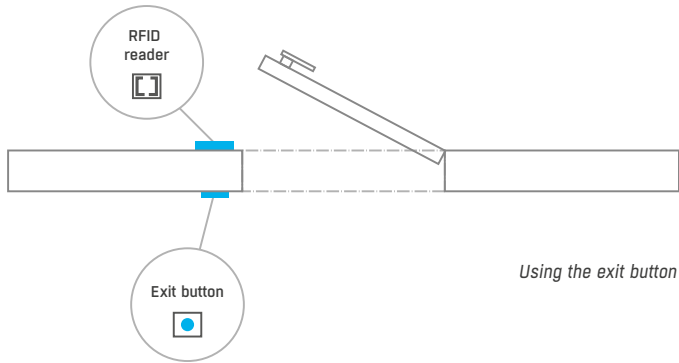

Access into a company building with a gate

HWg-SH4 can be used for entry gates on company parking lots. One RFID reader with a keyboard would control the entry gate and another reader with a keyboard would then control access into the building (the gate and the door require different codes assigned). An exit button can be used for leaving; eventually a second RFID reader can be used at the gate (can be then used for evidence of cars parked in the parking lot). Using the HWg-DCD is optional here as well.

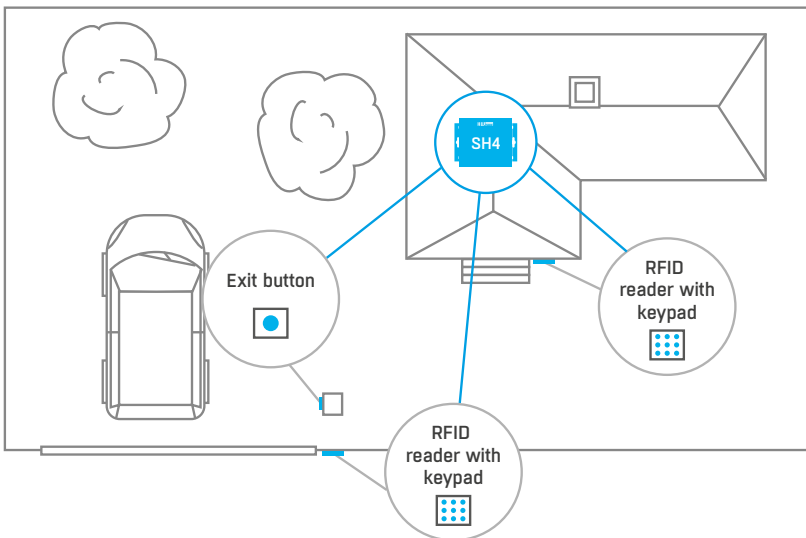

Building access system with availability for other applications

Thanks to the ability to use common RFID readers the HWg-SH4 is optimal for integration into existing systems. For instance in many schools and libraries there are some RFID tags systems already installed.

With HWg-SH4 you can easily assign access rights to a building by using the same tags. Also late arrivals are then recorded, the log can also be sent as e-mail or SMS notifications. The same can be applied in different office or storage premises.

Using HWg-SH4 in IT environment

A typical example is use of HWg-SH4 for access into rack cabinets and technological rooms.

Standalone solution for racks

A typical application for HWg-SH4 is in a rack cabinet, not only in individual cabinets but also as a part of a data center. HWg-SH4 unit is then installed inside the rack and the RFID reader is placed on one of the doors (or both). If there is only a single HWg-SH4, it can be simply configured in offline mode through its WWW interface.

However if HWg-SH4 is installed in a data center where one unit is installed in every cabinet, it is recommended to use the devices in online mode with HWg-DCD.

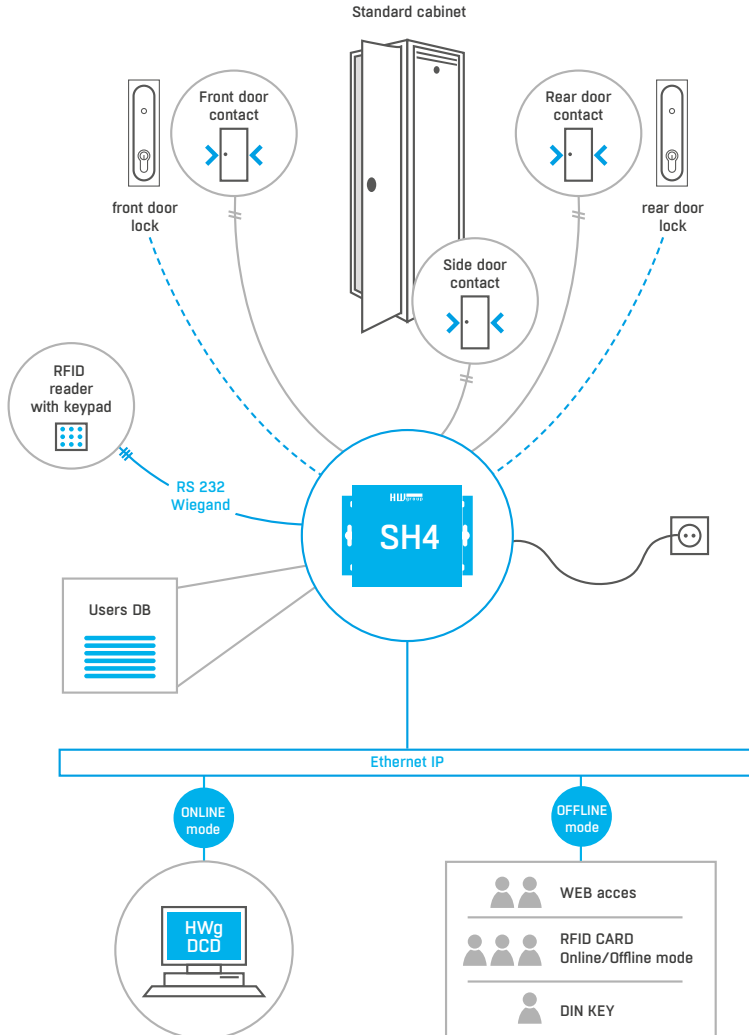

A solution using remote HWg-SH4e/HWg-SH4s units

One of the main advantages of the HWg-SH4 system is the option to use one control unit with several subordinated HWg-SH4e or HWg-SH4s units. In such cases a use of RFID reader with a keyboard connected to HWg-SH4 is expected. Individual doors have their own unique numbers corresponding with a door (key/lock) number or with a number of the rack cabinet (where the number is then used as a door code). Subordinated units HWg-SH4s or HWg-SH4e, which directly control the door locks, are installed in individual rack cabinets.

NOTE: The units (both head and subordinated) can also use relay type objects for example for lighting control in racks or for identification of the unlocked door. This function is not active in default.

A user enters a door code on the RFID reader's keypad and confirms the code with his RFID tag. The system then evaluates the request and opens the required door.

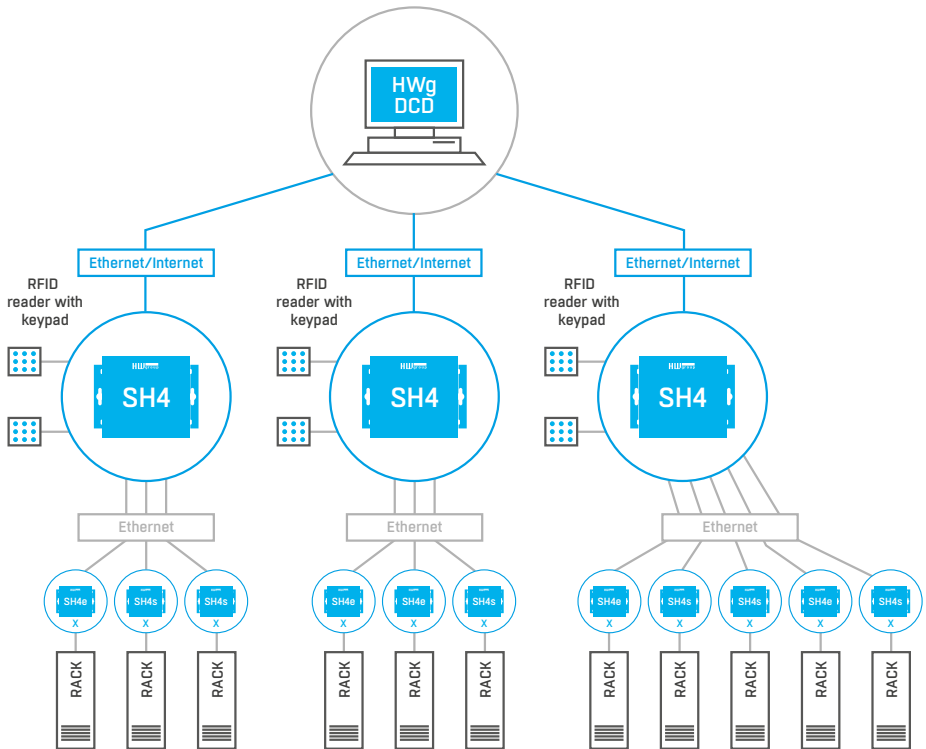

Solution with 8x HWg-SH4s

In this application the HWg-SH4 serves only as a terminal connected to an RFID reader, while subordinate units control all the locks. A door to be opened is defined by a code entered on the keypad.

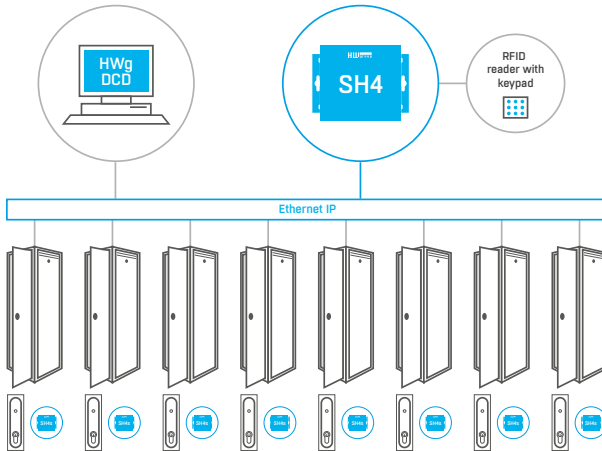

HWg-SH4 as another access point

In this configuration the HWg-SH4 works as an access point, it controls subordinate units and opens door as well. The door is selected with a code entered on a keypad.

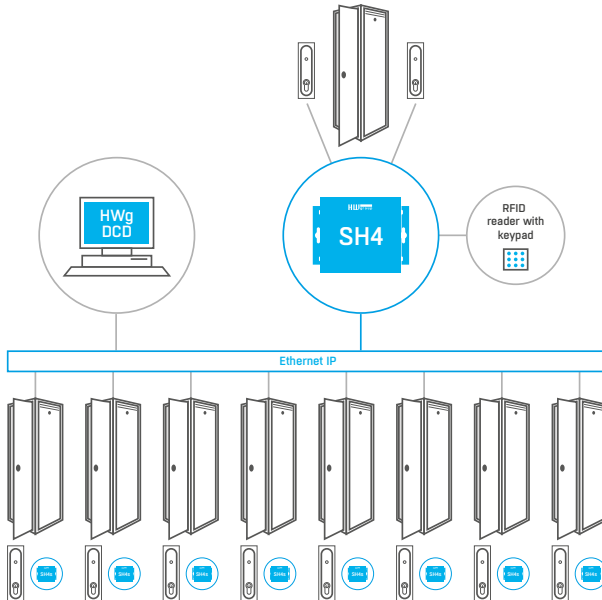

Description of the WWW interface

General setup

General Setup is used to set basic operational parameters of HWg-SH4.

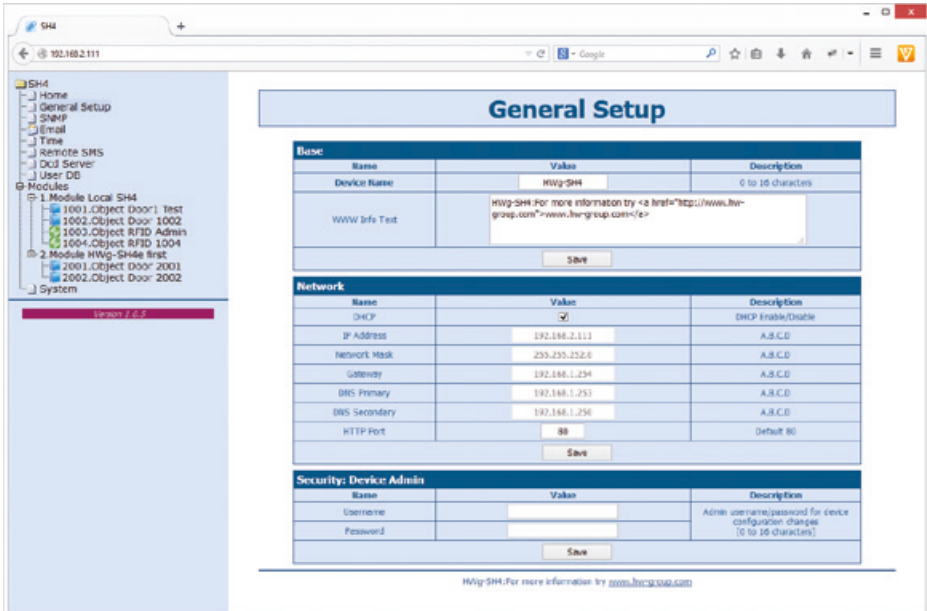

— Base section

- **Device Name** – (HWg-SH4) – helps to distinguish between different HWg-SH4's in one network. Device name can be up to 16 characters long
- **WWW Info Text** – text of a footer in WWW interface – useful for example for entering data center administrator's contact details

— Network section

- **DHCP** – allows DHCP server to set the IP address of the unit, if available. Enabling or disabling of DHCP depends on actual requirements of the user and the network administrator.
- **IP Address** – IP address of the HWg-SH4 – assigned by a network administrator.
- **Network Mask** – assigned by a network administrator.
- **Gateway** – IP address of a default gateway– assigned by a network administrator.
- **DNS Primary/DNS Secondary** – IP address of a DNS server – assigned by a network administrator.
- **HTTP Port** – port number where the built-in WWW server listens – changing the port number is necessary for example if more devices are accessible from outside the network through a router. Please consult any changes in this setting with your network administrator. Port set to 80 in default.

— Security: Device Admin section

- **Username/Password** – login details used for accessing HWg-SH4 settings

E-mail

E-mail tab defines e-mail server and parameters of alarm e-mail messages (starts or endings of alarm states).

Name	Value	Description
SMTP Server	some.smtp.server	IP Address or DNS Name
SMTP Port	25	Default 25
Secure TLS mode	<input checked="" type="checkbox"/>	Enable/Disable
Authentication	<input type="checkbox"/>	Enable/Disable
Username		0 to 32 characters
Password		0 to 32 characters
Importance	Normal	Email importance flag
FROM	user@domain.com	Device email address
Subject	subject	Beginning of email subject
TO	recpemp@domain.com	Email recipient
CC		Email Copy
Send Email when the door state changes	<input type="checkbox"/> Open/Close	
	<input type="checkbox"/> Lock/Unlock	
	<input type="checkbox"/> Fail/Normal	
	<input type="checkbox"/> Enable/Disable	
Send Email when RFD state changes	<input type="checkbox"/> Connect/Disconnect	Only for network modules
	<input type="checkbox"/> RFD Tag invalid code	
	<input type="checkbox"/> RFD Tag valid code	

Check this before sending an e-mail

1. Correct Gateway IP address
2. DNS server in the network settings
3. SMTP server and its port
4. Activated authentication and correct login name and password
5. Disabled spam filter of the mailbox

— Email Settings section

- **SMTP Server** – IP or domain address of a SMTP server.
- **SMTP Port** – port number of the e-mail server – in default port 25.
- **Secure TLS mode** – use this option if the SMTP server requires secured communication using SSL/TLS.
- **Authentication** – tick this option in case the SMTP server requires authentication.
- **Username** – necessary for SMTP server authorisation. If the Authentication field is not ticked, this is not used.
- **Password** – used for SMTP server authorisation. If the Authentication field is not ticked, this is not used.
- **Importance** – sets priority of the e-mail messages. Necessary for filtering and further processing of alarm messages.
- **FROM** – e-mail address of a sender - HWg-SH4 unit. Address can be required by SMTP servers and can be used for HWg-SH4 device identification, eventually for filtering and further processing of alarm messages.
- **Subject** – Content of this field can be used for identification of the HWg-SH4, eventually for filtering and further processing of alarm messages.
- **TO** – recipient – e-mail address of alarm e-mails recipient. Only one e-mail address can be entered.
- **CC** – copy – e-mail address of alarm e-mails copy recipient. Only one e-mail address can be entered.

Fields **To** and **CC** allow entering of more addresses or of a distribution list. For sending e-mails to more recipients it is necessary to have a distribution list in form of a single e-mail address (from your SMTP server administrator).

- **Send SNMP Trap when the door state changes** – Allows sending of notifications in case of selected events. Available event options:
 - **Open/Close** – Door opened or closed
 - **Lock/Unlock** – Door locked or unlocked
 - **Fail/Normal** – Door error – For specific lock types
 - **Enable/Disable** – Door object powered on or off (activated/deactivated)
 - **Connect/Disconnect** – only for network modules HWg-SH4e and HWg-SH4s
- **Send SMS when RFID state changes** – Allows sending of notification in case of a specific reader object event. Available events:
 - **RFID Tag invalid code** – unknown code loaded
 - **RFID Tag valid code** – valid code loaded

— Send Test Email section

A button for sending test e-mail messages after completing the e-mail settings.

Time

On the Time tab a system time and parameters for automatical synchronisation through timeservers are set.

The screenshot shows the 'Time' configuration page in the SH4 web interface. The page is titled 'Time' and contains three main sections: 'SNTP Setup', 'SNTP synchronize', and 'Time Setup'. The 'SNTP Setup' section includes a table with columns 'Name', 'Value', and 'Description'. The 'SNTP synchronize' section has a 'Sync' button. The 'Time Setup' section includes a table with columns 'Name', 'Value', and 'Description'. A sidebar on the left shows a tree view of the SH4 system structure.

Name	Value	Description
SNTP Server	europe.pool.ntp.org	IP Address or DNS Name
Time Zone	+1	Number: -12 ... +13
Summertime	<input checked="" type="checkbox"/>	let Sun Mar 2:00 · let Sun Oct 2:00
Interval	1h	Sync period: 07/15/24h

Name	Value	Description
Time	10 : 22 : 08	Hours
Date	09 - 06 - 2014	DD.MM.YYYY

— SNTP Setup section

- **SNTP Server** – IP address or a domain address of a time server – in default time.nist.gov.
- **Time Zone** – sets the time zone where the HWg- SH4 is located – required for events logging.
- **Summertime** – allows DST switching - required for correct logging of the measured values and events.
- **Interval** – interval of a time synchronisation with a server.

— SNTP synchronize section

Sync is used for an immediate synchronisation with a timeserver. Can be also used to test the entered settings.

— Time Setup section

Time Setup section allows you to enter actual time and date manually, in case you cannot use the synchronisation with a timeserver.

SNMP tab

SNMP tab sets the SNMP protocol communication options and sets the target destinations for SNMP traps.

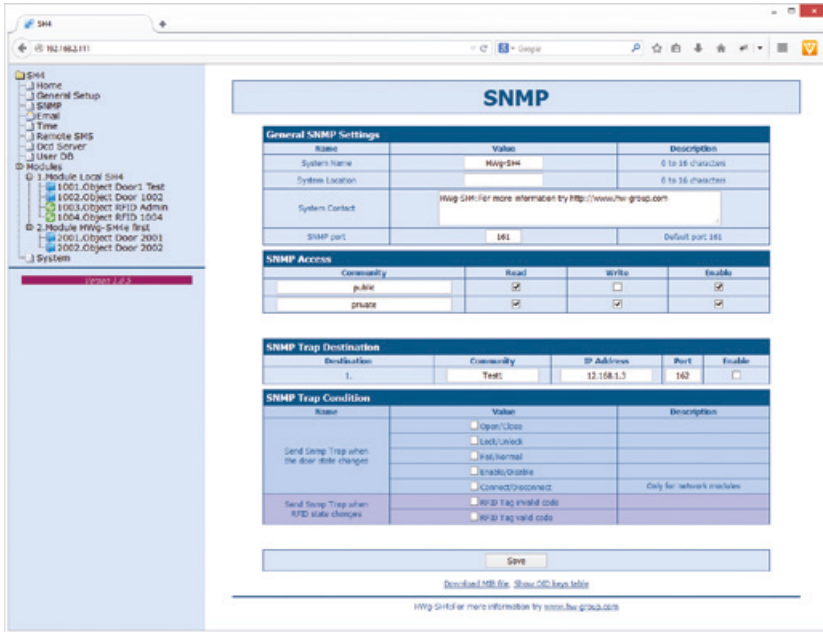

— General SNMP Settings section

- **System Name** – name of HWg-SH4 within SNMP
- **System Location** – position of HWg-SH4 within SNMP
- **System Contact** – HWg-SH4 administrator's contact details within SNMP
- **SNMP port** – port for SNMP communication – in default 161

— SNMP Access section

- **Community** – name of SNMP community for access to HWg-SH4 over SNMP. 2 communities can be defined and each can have rights assigned to:
 - **Read**
 - **Write**

— SNMP Trap Destination section

- **Destination** – index of a target destination for SNMP traps – only A – other indexes are reserved for future use
- **Community** – name of a Community, to which the SNMP trap is sent
- **IP Address** – target IP address for SNMP traps
- **Port** – target port for SNMP traps – in default 162
- **Enable** – activation of the target destination – allows to block sending of the traps in bulk, regardless the settings of individual values

— SNMP Trap Condition section

- **Send SNMP Trap when the door state changes** – Allows sending of notifications in case of selected events. Available event, options:
 - **Open/Close** – door opened or closed
 - **Lock/Unlock** – door locked or unlocked
 - **Fail/Normal** – door error – for specific lock types
 - **Enable/Disable** – door object powered on or off (activated/deactivated)
 - **Connect/Disconnect** – only for network modules HWg-SH4e and HWg-SH4s
- **Send SMS when RFID state changes** – allows sending of notification in case of a specific reader object event. Available events:
 - **RFID Tag invalid code** – unknown code loaded
 - **RFID Tag valid code** – valid code loaded

— Show OID keys table

This function prints out the full variables tree together with full SNMP OID and notes about the type of variables. For connecting HWg-SH4 into 3rd party monitoring system you may need a MIB file under the [Download MIB file](#) link.

The screenshot shows the HWg-SH4 web interface. The left sidebar contains a navigation menu with options like Home, General Setup, SNMP, Email, Time, Remote SMS, Doc Server, User DB, Modules, and System. The main content area displays the 'SNMP OID' table, which lists various system parameters and their corresponding SNMP Object IDs (OIDs).

SNMP OID Table	OID Key	Value	Description	Data Type	Access
	1.3.6.1.2.1.1.1.0	HWg-SH4	System Description	string	RO
	1.3.6.1.2.1.1.2.0	1.3.6.1.4.1.21796.4.6	System ObjectID	objid	RO
	1.3.6.1.2.1.1.3.0	121136500	System UpTime	timeticks	RO
	1.3.6.1.2.1.1.4.0	HWg-SH4-For more information try http://www.hur-group.com	System Contact	string	RO
	1.3.6.1.2.1.1.5.0	HWg-SH4	System Name	string	RO
	1.3.6.1.2.1.1.6.0		System Location	string	RO
	1.3.6.1.2.1.1.7.0	72	System Services	integer	RO
	1.3.6.1.4.1.21796.4.7.1.1.0	2	Module Number	integer	RO
	1.3.6.1.4.1.21796.4.7.1.2.1.1	1	1. Module Index	integer	RO
	1.3.6.1.4.1.21796.4.7.1.2.1.2	2	2. Module Index	integer	RO
	1.3.6.1.4.1.21796.4.7.1.2.1.2.1	Local SH4	1. Module Name	string	RO
	1.3.6.1.4.1.21796.4.7.1.2.1.2.2	HWg-SH4e first	2. Module Name	string	RO
	1.3.6.1.4.1.21796.4.7.1.2.1.3.1	1	1. Module Type	integer	RO
	1.3.6.1.4.1.21796.4.7.1.2.1.3.2	3	2. Module Type	integer	RO
	1.3.6.1.4.1.21796.4.7.1.2.1.4.1	0.0.0.0	1. Module Net module IP Address	string	RO
	1.3.6.1.4.1.21796.4.7.1.2.1.4.2	192.168.2.19	2. Module Net module IP Address	string	RO
	1.3.6.1.4.1.21796.4.7.1.2.1.5.1	8556	1. Module Net module Port	integer	RO
	1.3.6.1.4.1.21796.4.7.1.2.1.5.2	8556	2. Module Net module Port	integer	RO
	1.3.6.1.4.1.21796.4.7.1.2.1.6.1	4	1. Module Object Number	integer	RO
	1.3.6.1.4.1.21796.4.7.1.2.1.6.2	2	2. Module Object Number	integer	RO
	1.3.6.1.4.1.21796.4.7.1.3.1.1.1.1001	1001	1001. Object Index	integer	RO
	1.3.6.1.4.1.21796.4.7.1.3.1.1.1.1002	1002	1002. Object Index	integer	RO
	1.3.6.1.4.1.21796.4.7.1.3.1.1.1.1003	1003	1003. Object Index	integer	RO
	1.3.6.1.4.1.21796.4.7.1.3.1.1.1.1004	1004	1004. Object Index	integer	RO
	1.3.6.1.4.1.21796.4.7.1.3.1.1.2.2001	2001	2001. Object Index	integer	RO
	1.3.6.1.4.1.21796.4.7.1.3.1.1.2.2002	2002	2002. Object Index	integer	RO
	1.3.6.1.4.1.21796.4.7.1.3.1.2.1.1001	1	1001. Object Part ID	integer	RO
	1.3.6.1.4.1.21796.4.7.1.3.1.2.1.1002	2	1002. Object Part ID	integer	RO
	1.3.6.1.4.1.21796.4.7.1.3.1.2.1.1003	101	1003. Object Part ID	integer	RO
	1.3.6.1.4.1.21796.4.7.1.3.1.2.1.1004	102	1004. Object Part ID	integer	RO
	1.3.6.1.4.1.21796.4.7.1.3.1.2.2.2001	1	2001. Object Part ID	integer	RO
	1.3.6.1.4.1.21796.4.7.1.3.1.2.2.2002	2	2002. Object Part ID	integer	RO
	1.3.6.1.4.1.21796.4.7.1.3.1.4.1.1001	Door1 Test	1001. Object Name	string	RO
	1.3.6.1.4.1.21796.4.7.1.3.1.4.1.1002	Door 1002	1002. Object Name	string	RO
	1.3.6.1.4.1.21796.4.7.1.3.1.4.1.1003	RFID Admin	1003. Object Name	string	RO
	1.3.6.1.4.1.21796.4.7.1.3.1.4.1.1004	RFID 1004	1004. Object Name	string	RO
	1.3.6.1.4.1.21796.4.7.1.3.1.3.2.2001	Door 2001	2001. Object Name	string	RO
	1.3.6.1.4.1.21796.4.7.1.3.1.3.2.2002	Door 2002	2002. Object Name	string	RO
	1.3.6.1.4.1.21796.4.7.1.3.1.4.1.1001	0	1001. Object Cfg	integer	RO
	1.3.6.1.4.1.21796.4.7.1.3.1.4.1.1002	0	1002. Object Cfg	integer	RO
	1.3.6.1.4.1.21796.4.7.1.3.1.4.1.1003	1	1003. Object Cfg	integer	RO
	1.3.6.1.4.1.21796.4.7.1.3.1.4.1.1004	0	1004. Object Cfg	integer	RO

Remote SMS tab

Used to set parameters for sending alarm SMS messages via remote SMS gateway (with netGSM support).

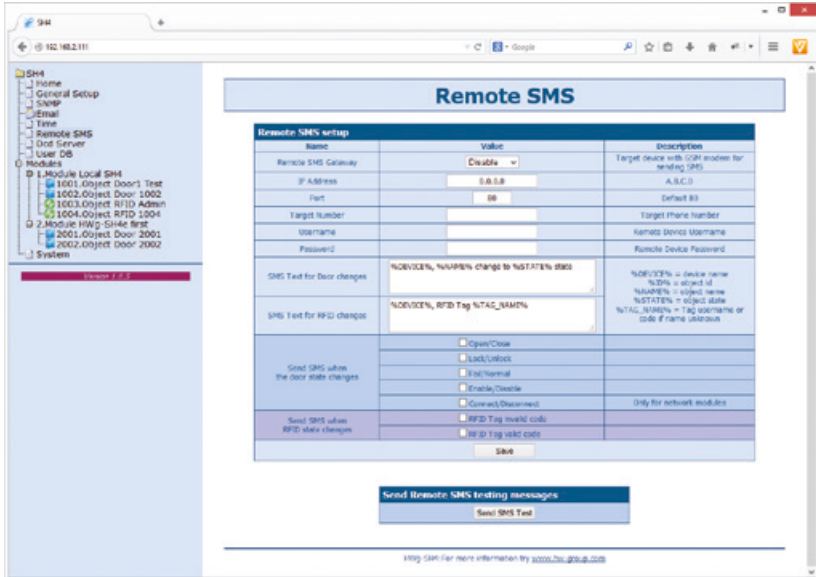

Remote SMS setup section

- **Remote SMS Gateway** – enables or disables this function
- **IP Address** – IP address of a remote gateway
- **Port** – TCP port of the gateway
- **Target number** – target number for SMS messages
- **Username** – username for the remote gateway. Can be left blank.
- **Password** – password for the remote gateway. Can be left blank.
- **SMS Text** – macro for creating SMS messages with information about return into the normal state.
- **Send SMS when the door state changes** – allows sending of notification in case of a specific event. Available events:
 - **Open/Close** – door opened or closed
 - **Lock/Unlock** – door locked or unlocked
 - **Fail/Normal** – door error – for specific lock types
 - **Enable/Disable** – door object powered on or off (activated/deactivated)
 - **Connect/Disconnect** – only for network modules HWg-SH4e and HWg-SH4s
- **Send SMS when RFID state changes** – allows sending of notification in case of a specific reader object event. Available events:
 - **RFID Tag invalid code** – unknown code loaded
 - **RFID Tag valid code** – valid code loaded

Send Remote SMS testing messages section

- **Test** – sends a test SMS

DCD server

This tab defines parameters of the DCD server connection.

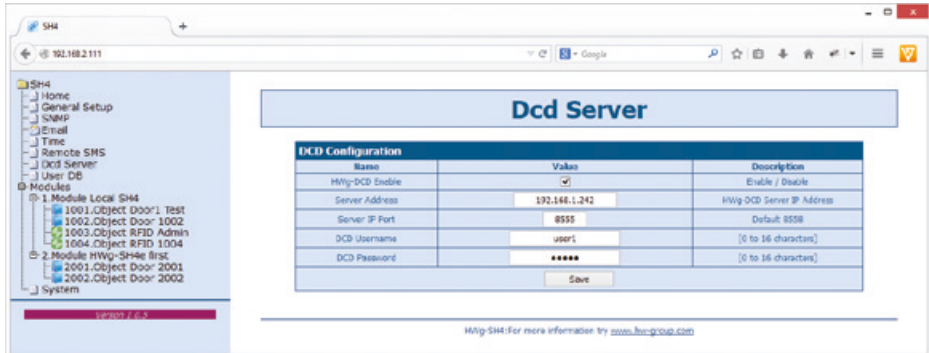

— DCD Configuration section

- **HWg-DCD Enable** – turns this function on/off (more in Functionality mode selection chapter):
 - **Enable** – online mode
 - **Disable** – offline mode
- **Server Address** – IP address of the HWg-DCD server
- **Server IP Port** – TCP port for HWg-DCD
- **DCD Username/DCD Password** – user login and password for HWg-DCD access

User DB

A tab used for managing the user tags database

User list is not available in the online mode and it can be edited only through the HWg-DCD application.

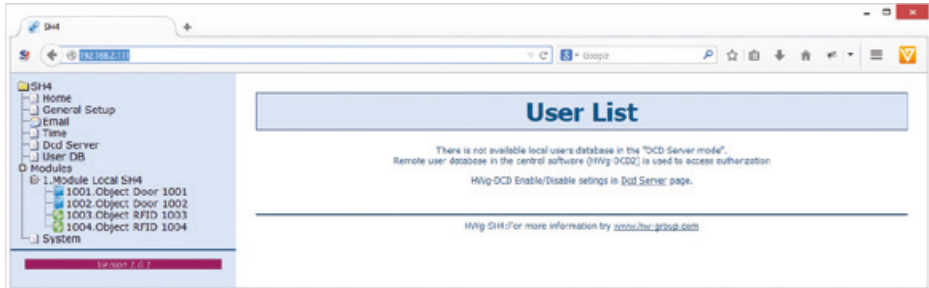

A log of accesses and a list of users with options of editing are displayed on this page in the offline mode.

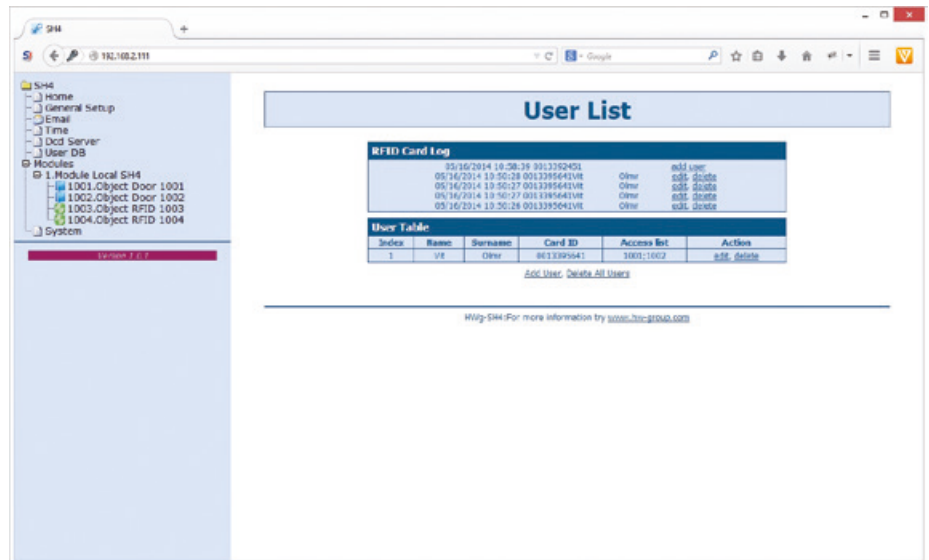

— RFID Card log section

Shows log of the most recent events, with options of adding and removing users. This option is very useful for managing larger amount of users. After reading the tag you can immediately start to work with the tag's details.

— User table section

- **Index** – unique identification of a user within the HWg-SH4.
- **Name** – first name of the tag user
- **Surname** – surname of the tag user
- **Card ID** – unique identification of an RFID tag
- **Access list** – a list of modules/doors, which this user can access.
- **Action** – an option for editing or deleting users

Add User link

Used for adding users

The screenshot shows the HWg-SH4 web interface. The left sidebar contains a navigation menu with options like Home, General Setup, Email, Time, Dcd Server, User DB, and Modules. The main content area is titled 'User List' and contains three sections:

- New User**: A form for adding a new user. Fields include Index (0), Account Enable (checked), Name, Surname, Card ID, and Doors access (Door access list: 1001,1002,2003). A 'Save' button is at the bottom.
- RFID Card Log**: A table showing RFID card activity. Columns include Date/Time, Card ID, and Action.
- User Table**: A table listing existing users. Columns include Index, Name, Surname, Card ID, Access list, and Action.

Index	Name	Surname	Card ID	Access list	Action
1	Vik	Olivr	0013395641	1901,1902	edit, delete

At the bottom of the User Table, there is a link: [Add User, Delete All Users](#).

Items in the **New User** section have the same importance as in the **User table** section.

Adding users

- Enter **Name** and **Surname** of the RFID tag user.
- Please use the **Card ID** field to enter a unique ID of the RFID tag, printed on the tag itself. The ID can be eventually found in the **RFID Card Log** section after you use the tag. You can also use an **Add user** link from the log itself.
- Use the **Doors access** field to enter the unique door IDs you want to control by this tag. This ID is identical to object's ID (door) in the **Modules** tab.

Modules

A tab for modules management, allows adding and removing of modules. Objects can be also managed from this tab.

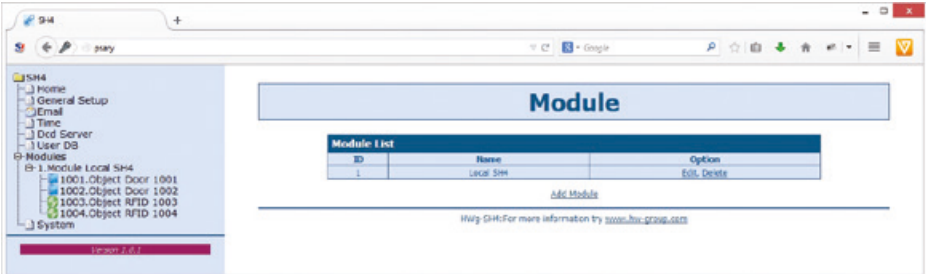

A list of currently connected modules is displayed on the Modules page. Only HWg-SH4e and HWg-SH4s modules and Hermes 10 (discontinued) can be connected to HWg-SH4.

Adding modules

Using the [Add Module](#) link can add new modules.

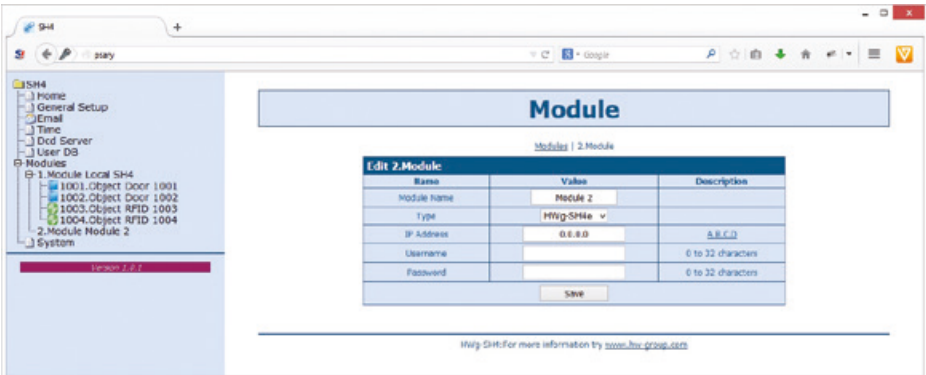

On this page it is necessary to add:

- **Module Name** – the module will be identified under this name in the HWg-SH4 and HWg-DCD systems.
- **Type** – type of the connected module. Available options are HWg-SH4e, HWg-SH4s and Hermes10 (discontinued).
- **IP Address** – IP address of the connected module. If you enter an address of a device, which was not assigned to any system yet, HWg-SH4 will automatically reconfigure the device for cooperation.
- **Username/Password** – communication between the modules and the control unit is secured with a user login and a password. **Username** and **Password** in the subordinated unit have to correspond with details in HWg-SH4.

After adding a module to the system, a configuration is automatically downloaded and the objects can be then managed as a part of the system.

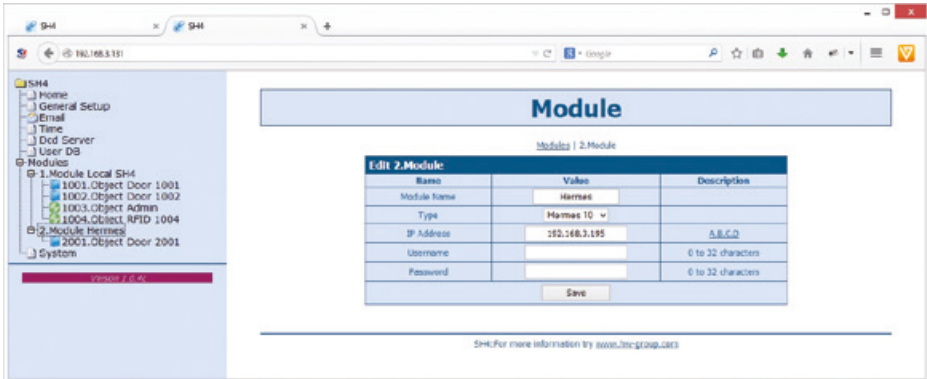

Objects configuration

This page is used for thorough configuration of objects, as setting the locks types, RFID readers, etc.

Door type object

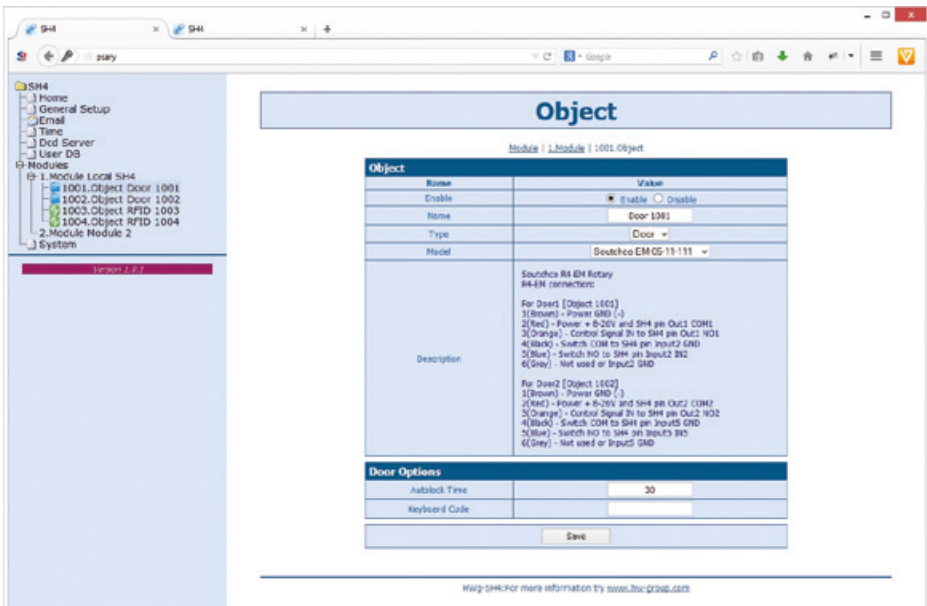

— Object section

- **Enable** – enables/disables the object. If an object is disabled, its configuration and states are not being transferred to the DCD and not even to the WWW page of the device. This makes orientation in the system easier, as you can exclude objects that are not in use.
- **Name** – Object name makes the orientation in objects easier. Can be named for instance as the number of door it controls, by identification number of the rack, etc.
- **Type** – determines the object type. Item defined in the firmware, this field is prepared for future use
- **Model** – defines type of the connected accessories and therefore also types of the connected elements
- **Description** – shows the elements' connection description (wire colours can vary according to manufacturers of locks or readers). A list of compatible locks can be found on the manufacturer's website or requested from your local distributor.

— Door Options section

This section sets the behaviour of door locks:

- **Autolock Time** – time for which the door stays unlocked / unblocked. The time is set in seconds
- **Keyboard Code** – sets the numeric code for the RFID reader keypad, used for unlocking individual door locks.

RFID type object

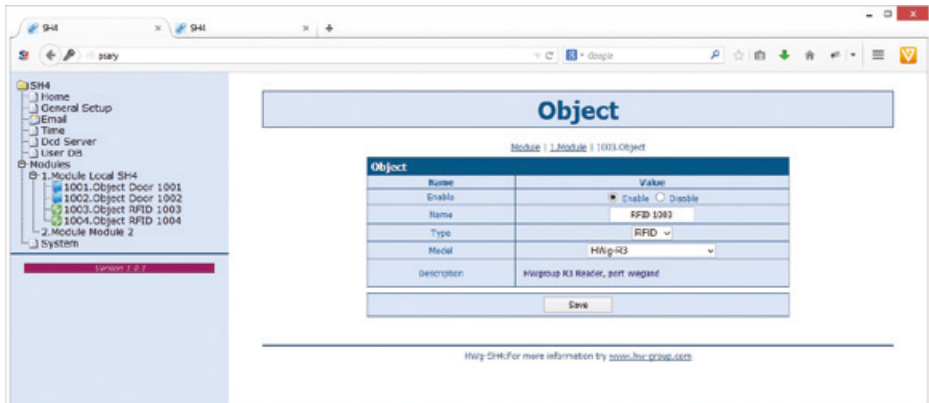

System tab

System tab offers access to main system details such as uptime and firmware version. It also offers restart options or tools for firmware update.

The screenshot shows the SH4 web interface. The left sidebar contains a navigation menu with categories like Home, General Setup, SNMP, JMail, Time, Remote SMS, Dcd Server, User DB, and Modules. The main content area is titled 'System' and contains several sections:

- Download**: A table with columns 'Description' and 'File'. It lists 'Backup configuration' with the file 'SH4_Config.bin'.
- System**: A table with columns 'Name' and 'Value'. It displays system information:

Name	Value
Version	2.9.9
Compile time	Jun 5 2014, 12:24:34
Build	4170
UpTime	14 min
Demo Mode	Demo Mode Enable
- Factory Default**: A button labeled 'Default'.
- System Restart**: A button labeled 'Restart'.

At the bottom of the main content area, there are buttons for 'Procházet', 'Soukromý navedení', and 'Upload'. The footer contains the text: 'HWg SH4. For more information try www.hw-group.com'.

— Download section

- **Backup configuration** – by clicking the link you can save the actual HWg-SH4 configuration and later restore this configuration or load it to another device
- **SNMP MIB Table** – SNMP MIB file – address of a MIB file, containing definition of SNMP variables
- **TXT list of common SNMP OIDs** – a list of the most frequently used OIDs from the MIB chart

— System section

- **Version** – firmware version. Diagnostic information for troubleshooting
- **Compile time** – firmware compilation time. Diagnostic information for troubleshooting
- **Build** – diagnostic information for troubleshooting
- **UpTime** – uptime since last power-on or reset of the device Diagnostic information for troubleshooting.
- **Demo mode** – activated demo mode disables changes in configuration of your device. Visitors can freely browse all pages of the WWW interface in this mode but they cannot make any changes. The device can be then made available on a public network without any risk of problems with settings.
- **Upload Firmware or Configuration** – allows users to upload new firmware or a configuration file. Uploaded configuration may not be compatible in case the difference between firmware releases is too large.

— Factory Default section

Restores the factory default settings. The default IP address is 192.168.10.20 and both login and password are not set.

HWg-DCD

The HWg-DCD application is used for centralised management of users and end points (objects) of the HWg-SH4 access system. This application offers easy and fast adding and editing of objects, with options for sorting by groups or locations. It also offers a register of users with options for sorting into groups, and a complete control over access rights for doors and users.

Basic features

- Quick object overview (*open/closed, unlocked/locked, set/open*)
- Manual door control
- Options for sorting objects into groups by locations
- Options for sorting objects into groups by types (*door*)
- Complete management options for objects, including the locks settings, RFID readers settings, etc.
- User accounts management with e-mail addresses and phone numbers log.
- Sorting users into groups
- Drag and drop options for managing users and objects
- Remote management options in client/server system
- Server application with extended logging capacity.
- Access log and event log mirroring from HWg-SH4 to HWg-DCD
- Communication between the device and HWg-DCD based on events or periodical checks (*Heartbeat*)

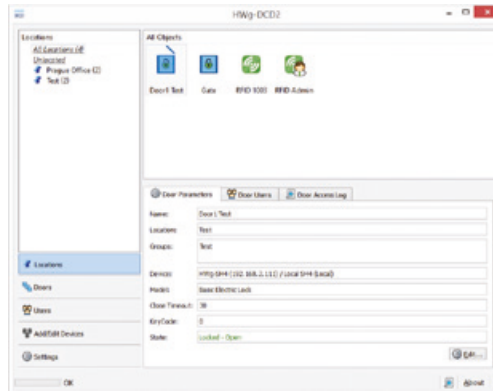

Ways of communication between HWg-SH4 and HWg-DCD

Communication between HWg-SH4 and DCD is done via a closed and encrypted protocol of HWg-DCD, based on the TCP/IP principle where the HWg-SH4 is a TCP client. Each unit creates a permanent TCP connection after it is powered on and in case that any event appears on the side of HWg-SH4 (*loaded card, entered code, door opened...*), the device notifies the server. The device also periodically notifies the server confirming that all functions are working correctly (*heartbeat*). Administrator of HWg-DCD will immediately know about any change of states, but also about connectivity losses.

After the device is connected, the HWg-DCD downloads configuration from the device. Based on that it creates a template and changes the configuration according to actual settings of the device. These parameters can be confirmed or changed by administrators.

Configuration changes are processed in both DB and the device at the same time in order to make work with HWg-DCD more fluent.

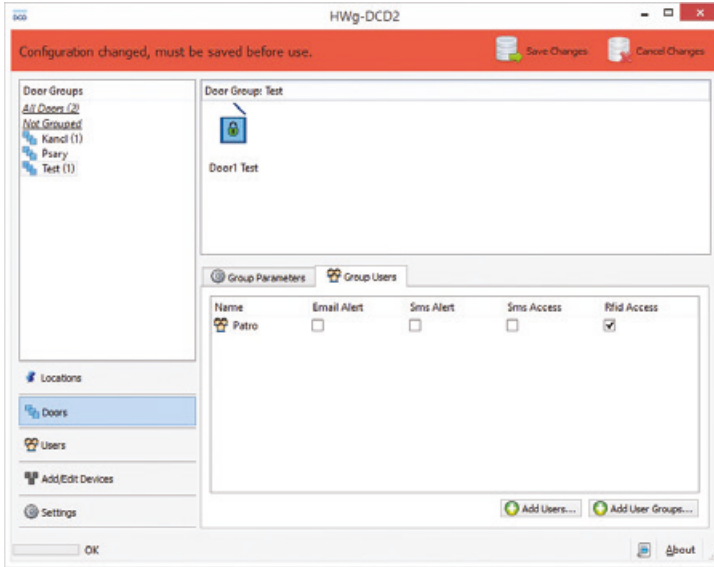

Connection between HWg-SH4 and HWg-DCD is caused by any action on the side of the HWg-SH4, or randomly in 30-90s period. Any changes done in HWg-DCD will then be applied in less than 90 seconds. Information window shows details about the synchronization.

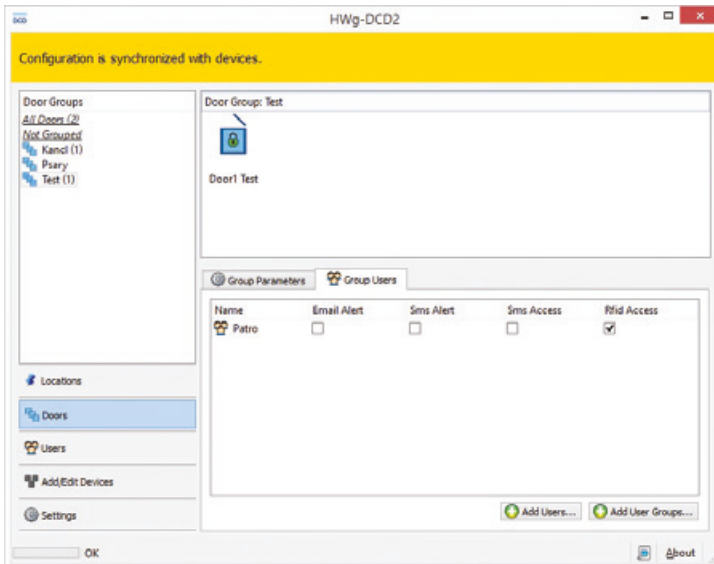

HWg-DCD interface

Visual interface of the HWg-DCD is designed to be intuitive and familiar to most users. You can control the application by dragging items between the windows or by using the context menu available under right-clicks on items or in the window field.

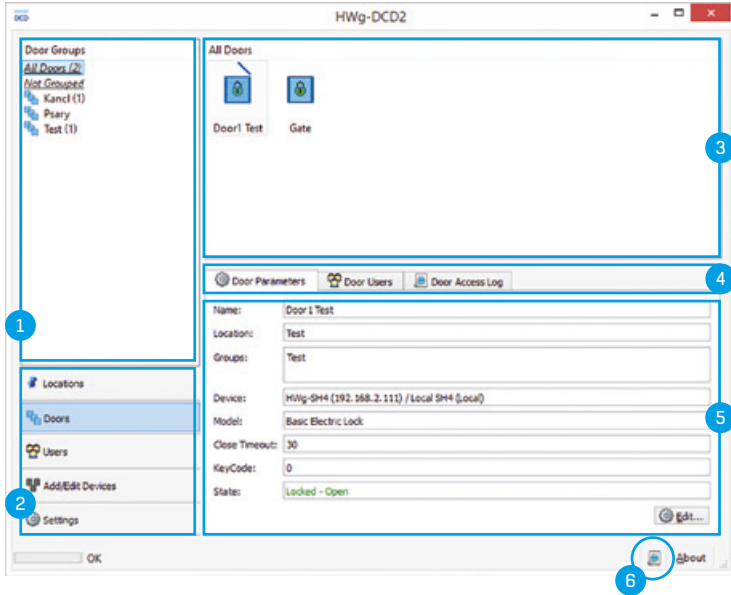

The screenshot shows the HWg-DCD application window. On the left, there is a 'Door Groups' tree view (1) and a 'Locations' sidebar (2). The main area is divided into 'All Doors' (3) and 'Door Parameters' (4). The 'Door Parameters' window (5) shows details for 'Door 1 Test', including location, groups, device, model, close timeout, key code, and state. An 'About' button (6) is visible at the bottom right.

- 1 Group window
- 2 View selection
- 3 Objects window
- 4 Parameters tabs
- 5 Properties window
- 6 Events log

View selection

Allows switching the view in HWg-DCD and it is the most important part of the application.

- **Locations** – Locations define the physical position of objects (doors, readers, relays). Allows defining and grouping of components placed at the same locations. Door objects connected to the same device can be placed in different groups; also door and reader objects can be placed in same or different groups based on their real position.

Groups can be created in more levels, but each object can be placed only in one location.

Locations can have sublocations to be more accurate:

- Server House Brno
 - Building A
 - 1st floor
 - Section A
 - Section B
 - Row 1
 - Row 2
 - 2nd floor
 - Building B
- Server House Praha

- **Doors** – Shows individual door type objects and allows administrators to group the objects into logical units (*HW group Praha, HW group Wien, HW group London, etc.*). One door can be part of any number of groups. This view does not show RFID or relay type objects, only the door objects.
- **Users** – shows individual users and allows administrators to group them into logical units (*HW group, workshop, sales, etc.*)
- **Add/Edit Devices** – Used for adding and editing devices and objects and for their sorting by **locations**. Groups shown in the Locations and **Add/Edit Devices** lists are identical, but offer different view on the situation. **Add/Edit Devices** does not show the locations of devices, but locations of HWg-SH4 and HWg-SH4e control units.
- **Settings** – Basic settings of the application, server's service IP address (In case the service is not running on the same device as user GUI), behaviour of GUI for folders browsing and default display options.

Group Window

Group window displays the trees of locations, doors and users. Default view is All xxxxx (*All doors, All users, All devices, All Objects*). In the objects window you can then see contents of the selected group. All xxxxx and Unlocated (*Ungrouped*) groups are system groups and cannot be removed.

Objects window

shows a complete list of objects connected to a selected group.



Door closed and locked



Door opened and locked – legally opened, can be now closed



Door opened, unlocked



Door closed and unlocked – can be opened



Door error – forced entry



Door disconnected – communication lost



RFID reader



RFID reader with admin rights



Error in communication with RFID reader



Error in communication with RFID reader with admin rights

Clicking a door icon will open the connected door. Right clicking the icon will open a context menu with options.

Settings window

Settings window shows an overview of settings and access right and offers an option to edit the contents. Settings are different for various view options and for individual objects. Also the switching parameters can be changed as needed.

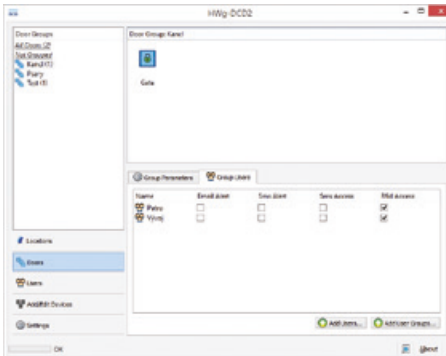

List of group parameters

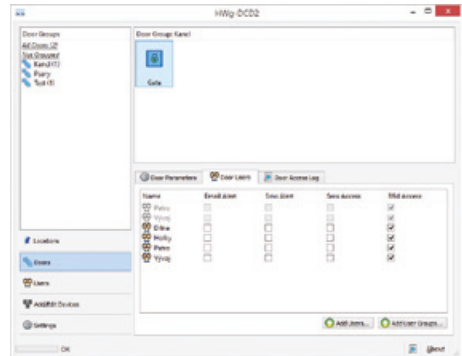

Object properties

Parameters tabs

The tabs are used to switch between properties of objects and groups where it is relevant.

Events log

Events log in the HWg-DCD is useful for calibrating the application or for dealing with client's problems with the system. More information can be found in [Application](#) note on the manufacturer's websites or on request from your local distributor.

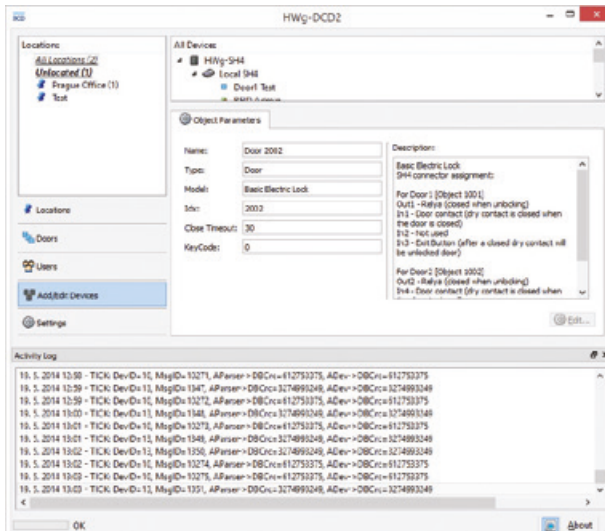

Typical operations

Adding and removing groups

To add or remove a group switch to a required view and with a right-click into the group window, or directly on a group name, open a dialog for adding/removing groups.

Adding users

Go to Users tab by switching the views and with a **New User** button open the New User window. **Card Number** field can be filled in manually or after clicking the administrator RFID reader icon a card with admin rights can be read.

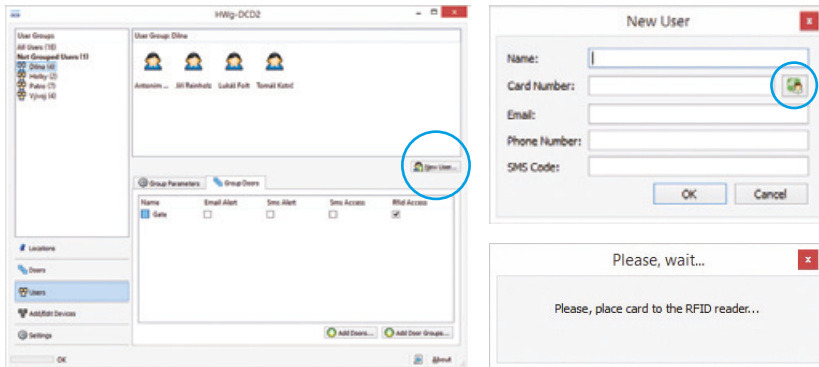

Erasing and editing accounts

Users can be edited after clicking the Edit button on the **User parameters** tab. Users can be erased by selecting an account and pressing a **Delete** button.

Adding devices

In the tabs list you can activate **Add/Edit Devices** mode. You can then see all subordinated devices in the objects window. Choose an object and open an adding dialog window by right clicking on this object.

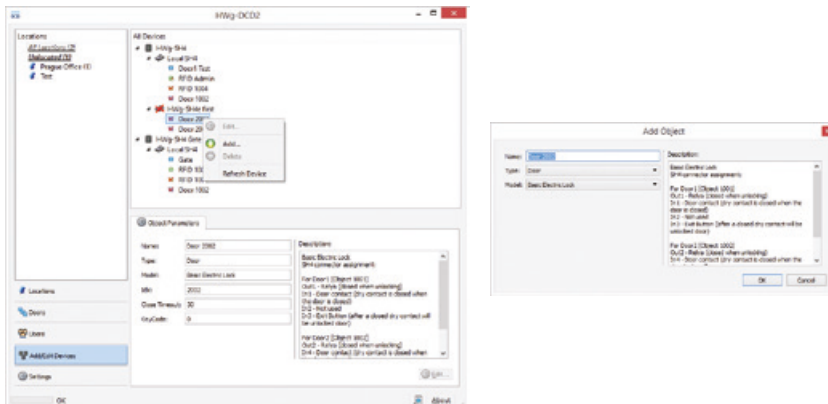

Technical specifications

ETHERNET	
Interface	RJ45 (100BASE-Tx) – 10/100 Mbps network compatible
Supported protocols	IP: ARP, TCP/IP (HTTP, NTP, SMTP, HWg-DCD), UDP/IP (SNMP)
SNMP compatibility	Ver.1.00 compatible, partial ver.2.0 implementation

User database	
Size	Max. 2000 users

RFID Reader	
Type	Wiegand or RS-232
Connector	2xRJ-45

DI - INPUTS for Dry Contact	
Type	Digital Input (supports NO/NC Dry contact)
Sensitivity	1 (On) = 0-500 Ω
Max. distance	Up to 50m

OUTPUTS	
Max. voltage	60V AC/DC
Max. load	Max 1A, up to 60VA/24W (0.5A/48V)
State	Power up state (no state restart memory)

POWER input	
Port	POWER 12V DC
Power input	12V DC / 2,5W (typically 250 mA) Connectors: Jack (barrel, inner 2.5 mm outer 6.3 mm) + Terminal Block

POWER output	
Voltage	Power Out = Power IN
Current / Connector	Max. 150mA / Terminal Block

LED Status indicators	
POWER (RJ45 + top)	Green - power OK (top), Ethernet enabled (RJ45)
LINK & Activity (RJ45)	Yellow - Ethernet connectivity
Setup / Alarm	Red
Inputs	Green
Outputs	Yellow
HWg-DCD Connection	Blue

DIP SWITCH	
DIP1: Setup	OFF = Normal state Load defaults: Set ON, power-up device, toggle 3 times during first 5 seconds
DIP2: Security	MUST be OFF

Physical parameters	
Temperature range	Operating: -30 to +85 °C / Storage: -35 to +85 °C
Dimensions / Weight	145 x 90 x 45 [mm] / 225 g
EMC	FCC Part 15, Class B, CE - EN 55022, EN 55024, EN 61000

Power supply output

HWg-SH4 offers **PWR OUT** for power supply of connected sensors and detectors, for instance smoke detectors.

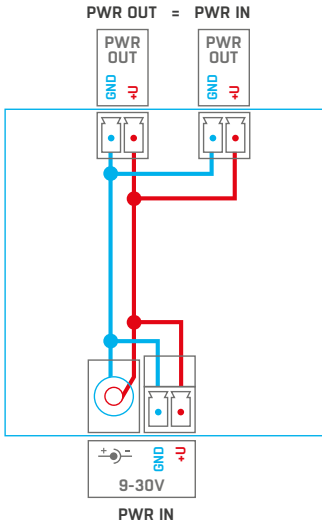

! Voltage on PWR OUT is equal to the input voltage of the HWg-SH4!

Relay outputs

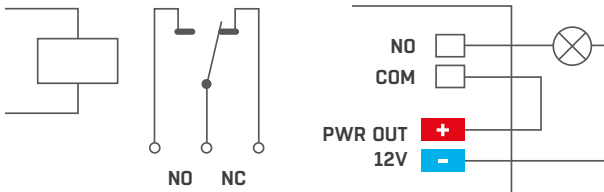

- NO and NC notes apply for normal state - 0 (*Off*) and for switched off devices
- In case the output is in state 1 (*On*), the “*Normally Open*” (NO) output relay is connected
- **Signalisation:** set / open states of the relay are distinguished by a LED light
- **Isolation:** Switch contacts are galvanically isolated from the rest of the device.

Inputs - DI inputs for binary contacts

Inputs - DI inputs for binary contacts Dry contacts or GND pins can be connected to terminal blocks on digital inputs. Inputs are galvanically connected to the 12V power supply.

Unoccupied/Inactive input is marked as „0 (*Off*)“.
Active input is marked as „1 (*On*)“

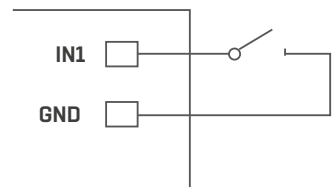

Connecting HWg-SH4 accessories

Connecting RFID readers

RFID readers can be connected to HWg-SH4 by a pair of **RJ45** connectors. Only one reader can be connected to each connector (object). Types of connected readers can be different.

RJ45 standard B - colours	Function	HWg-R3	JA-8H
white / orange	1 - out 1	gray	yellow
orange	2 - out 2	purple	x
x	3 - Txd	x	x
blue	4 - GND	black	blue
x	5 - in 1	x	x
green	6 - D0/Rxd	green	green
white / brown	7 - +12V	red	red
brown	8 - D1	white	brown

Connector RJ-45F DN93612 is supplied with HWg-SH4 as an optional accessory.

Connecting HWg-R3 RFID reader

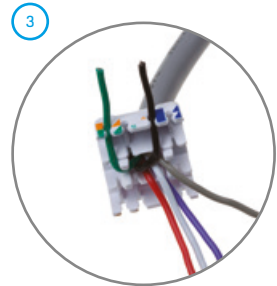

Take off approximately 3cm of the outer isolation of the connecting cable and draw the cable through the top part of the connector - DN93612.

Then place the individual conductors of the cable to their positions on the connector's top part.

4



5



6



Cut off the spare parts of the conductors just at the side of the top part.

7

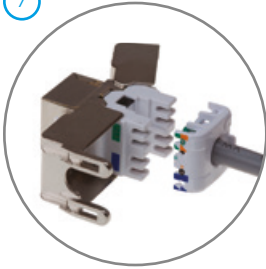

Attach the head part to the connector's body and press the parts firmly together.

8

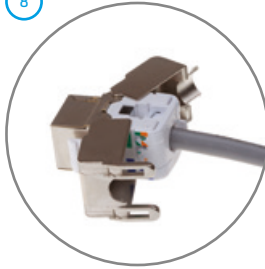

The metal body of the connector can be used to press the parts together to properly cut the conductors through.

9

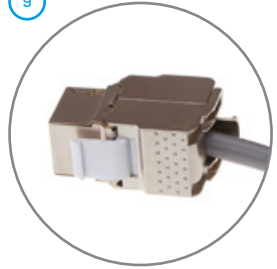

10

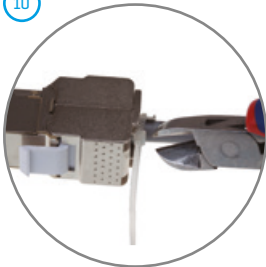

Use the supplied strap to prevent the cable from being pulled out of the connector. Cut off the spare part of the strap.

11



12

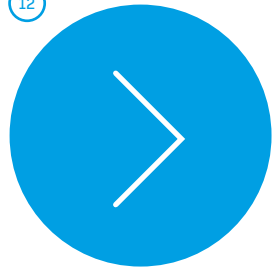

Check the correct functionality of the reader.

Connection of individual lock types

Basic Electric Lock

Connection rules for different elements

- **Out1** - Relay (closed when unlocking)
- **In1** - Door contact (dry contact is closed when the door is closed)
- **In2** - Not used
- **In3** - Exit Button (closing the dry contact unlocks the door)

Connecting lock E-lock BeFo 512

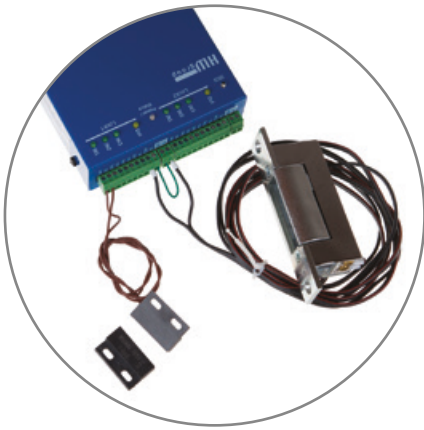

Connection with exit button included (optional) + detail of connection

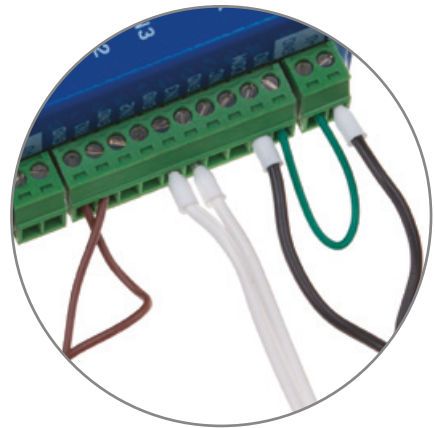

Connecting E-lock XPO-211 lock + detail of connection

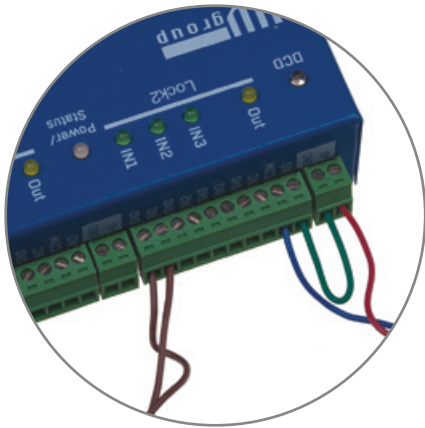
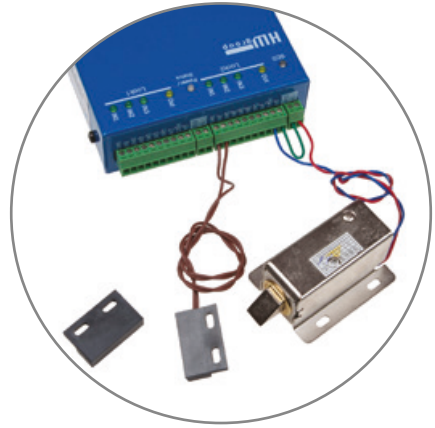
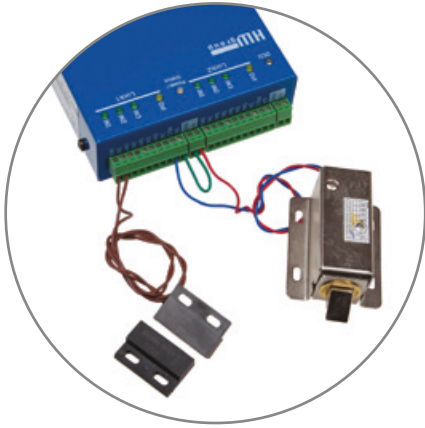

Southco HWg-SH1 + detail of connection

green	white	Power GND = Power Out GND pin
green		Power +12V = Power Out +U pin
	X	Not used
orange		Control Signal to Rele NO pin - Rele COM connect to Power Out +U pin
blue	white	Lock status to IN2 pin
blue		Mech status to IN3 pin

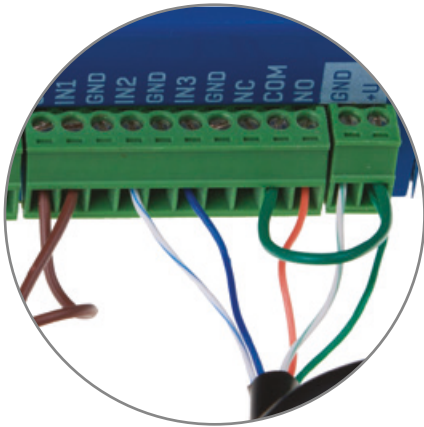

Restoring the default settings

The following steps will restore the factory default settings of the device (**also erases all passwords**):

1. Turn the device off by disconnecting the power supply
2. Switch the DIP1 ON
3. Turn the device on (switch the power supply)
4. Wait approximately 15 seconds
5. Turn off the power supply
6. Turn the DIP1 OFF
7. Turn the power supply back on

Notes



HW group s.r.o
Rumunská 26/122
Praque 2, 120 00
Czech republic

Tel.+420 222 511 918
Fax.+420 222 513 833

www.HW-group.com